

Technical Data Sheet  
Electric Motor 1 phase in Aluminum IE2

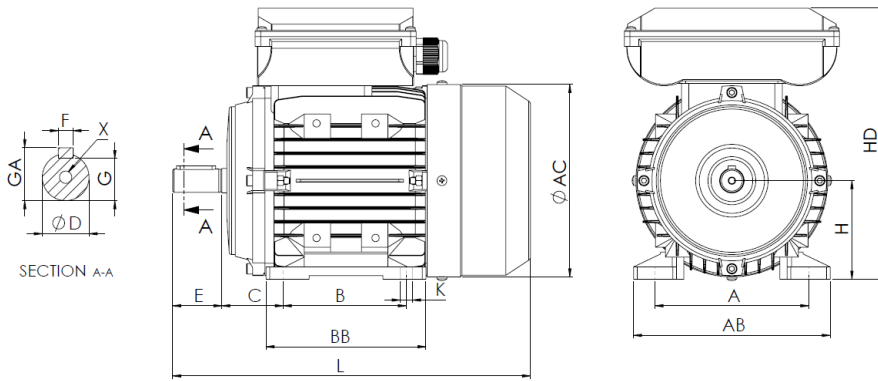

L (standard motor)  
255  
L (motor w/brake)  
NA  
L (motor w/forced ventilation)  
349  
L (motor without ventilation)  
218

Feet					Shaft						Carcass				Flange				
H	A	B	C	K	D	E	F	G	GA	X	AB	BB	AC	HD	M	N	P	S	T
71	112	90	45	7	14j6	30	5	11	16	M5x12	132	104	139	194	-	-	-	-	-

Electrical Data				Mechanical Data			
Type	UMM2D 71M2-4			Shaft height	71		
Poles	4/1500	Poles		Construction form	B3		
Power	0.37	Kw		Mechanical protection	55		
Voltage	230	V		Heating class	B		
Frequency	50	Hz		Insulation class	F		
Speed	1430	rpm		Service	S1		
Nominal current	2.24	A		Ambient temp.	-10°C-40°C		
Power factor	0.99			Altitude	1000		
Efficiency 100%	72.7	%		Noise	-	dB(A)	
Efficiency 75%	66.9	%		Weight	7.61	kg	
Efficiency 50%	55.5	%		Bearing DE	6202 2Z C3		
Torque	2.47	N.m		Bearing NDE	6202 2Z C3		
Ta/Tn	2.4						
Ia/In	5.4						
Tm/Tn	1.7						

**Extra Data**

**Applicable brakes**

DC brake	NA	Brake torque	NA	N.m
AC brake	NA	Brake torque	NA	N.m

**Applicable forced ventilations**

Single-phase forced ventilation	Power	35	W
Three-phase forced ventilation	Power	NA	W

Universal Motors S.A.  
Rua Comendador Brandão, 484  
4495-375 Póvoa de Varzim  
[geral@universalmotors.pt](mailto:geral@universalmotors.pt)  
TEL.: 252 299 080

Universal Motors UK, Ltd  
Unit E2, Meltham Mills Road  
West Yorkshire HD9 4AR  
[enquiries@universalmotors-group.co.uk](mailto:enquiries@universalmotors-group.co.uk)  
TEL.: +44(0) 1484660222

Universal Motors SL  
C/La Habana n.6 nave 4 PI Camporoso  
28806 Alcala de Henares  
[info@universalmotors-group.es](mailto:info@universalmotors-group.es)  
TEL.: 918 864 213