

MODEL	X225	
Ø OUTPUT SHAFT	20	mm
APPROXIMATE RATIO	13	
EXACT RATIO	14.07	
OUTPUT SPEED	112	RPM
EXACT OUTPUT SPEED	104	RPM
INPUT POWER	0.25	KW
INPUT ROTATION	1400	RPM
INPUT PAM	71B14	
OUTPUT TORQUE	23.03	N.m
NOMINAL TORQUE	45.00	N.m
NOMINAL POWER	0.53	KW
SERVICE FACTOR	2.12	
DYNAMIC EFFICIENCY	0.96	

Oil Quantity (L)

B3/H1	B6/H4	B7/H3	B8/H2	V5/H5	V6/H6
0.25	0.25	0.25	0.25	0.43	0.31

Radial and Axial Loads



n_2 [min-1]	FA [N]	FR [N]
400	360	1800
150	420	2100
75	440	2200
25	440	2200

PX22SC... Basic Gearbox
Riduttore base

Gearbox weight
peso riduttore **3.70 kg**

M. flanges	Kit code	øF	A
63B5	K050.4.041	138	154.5
71B5	K050.4.042	160	152
56B14	KC40.4.049	80	152
63B14	K050.4.047	90	154.5
71B14	K050.4.045	105	152

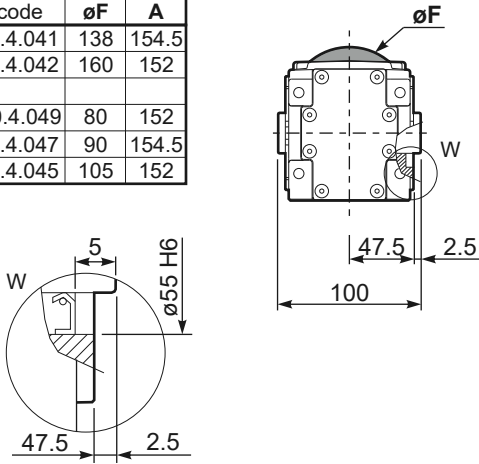

PX22S...**FB**.. Feet
Piedini



PX22S...**-F1**.. Output flange
Flangia uscita



PX22S**A**.. Single output shaft
Albero semplice in uscita



PX22S...**BR**.. Reaction Arm
Braccio di reazione



RX22S.. Input shaft
Albero in entrata

