

MODEL	X43A	
Ø OUTPUT SHAFT	25	mm
APPROXIMATE RATIO	231	
EXACT RATIO	230.79	
OUTPUT SPEED	6	RPM
EXACT OUTPUT SPEED	6	RPM
INPUT POWER	0.12	KW
INPUT ROTATION	1400	RPM
INPUT PAM	63B5	
OUTPUT TORQUE	177.57	N.m
NOMINAL TORQUE	150.00	N.m
NOMINAL POWER	0.11	KW
SERVICE FACTOR	0.92	
DYNAMIC EFFICIENCY	0.94	

#### Oil Quantity (L)

B3/H1	B6/H4	B7/H3	B8/H2	V5/H5	V6/H6
0.8	0.8	0.6	0.8	1.2	0.7

#### Radial and Axial Loads



$n_2$ [min-1]	FA [N]	FR [N]
250	500	2500
100	700	3500
50	960	4800
15	960	4800

**PX43AC...** Basic Gearbox  
Riduttore base

Gearbox weight  
peso riduttore **7.93 kg**

M. flanges	Kit code	øF	A
<b>63B5</b>	K050.4.041	138	205
<b>71B5</b>	K050.4.042	160	202.5
<b>56B14</b>	KC40.4.049	80	202.5
<b>63B14</b>	K050.4.047	90	205
<b>71B14</b>	K050.4.045	105	202.5



4 holes M8x12  
Mounting holes position  
Posizione fori di montaggio

**PX43A...FB..** Feet  
Piedini

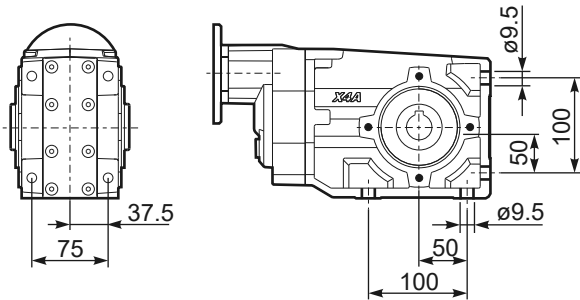

**PX43A...-F2..** Output flange  
Flangia uscita

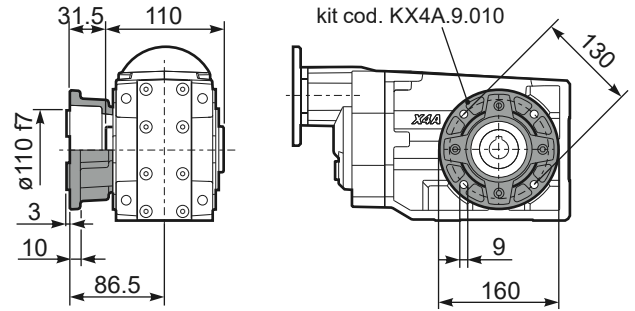

**PX43A...-F3..** Output flange  
Flangia uscita

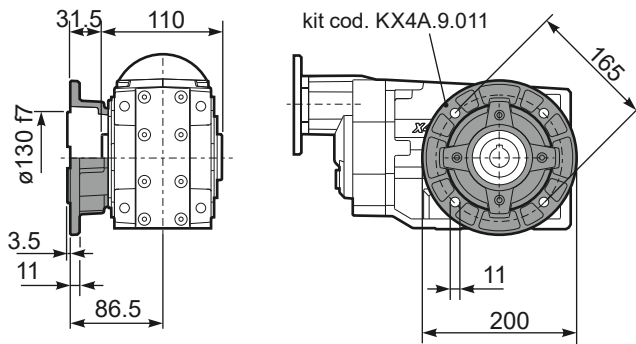

**PX43A...BR..** Reaction Arm  
Braccio di reazione

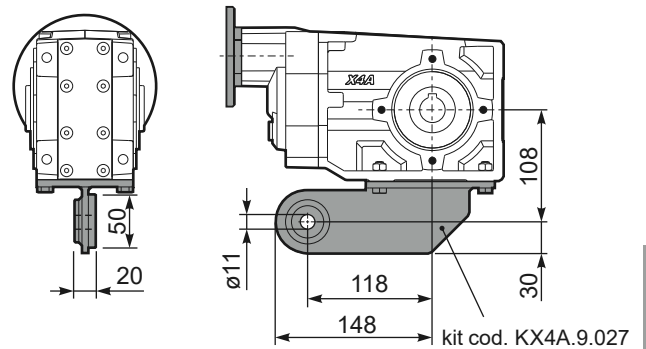

**RX43A...** Input shaft  
Albero in entrata

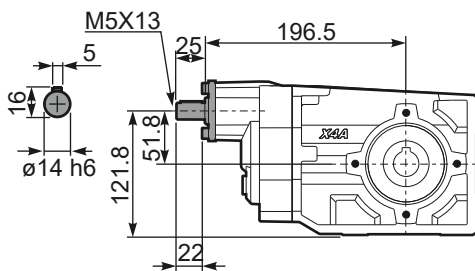

**PX43AA..** Single output shaft  
Albero semplice in uscita

