

MODEL	X52A	
Ø OUTPUT SHAFT	30	mm
APPROXIMATE RATIO	11	
EXACT RATIO	11.36	
OUTPUT SPEED	133	RPM
EXACT OUTPUT SPEED	129	RPM
INPUT POWER	1.50	KW
INPUT ROTATION	1400	RPM
INPUT PAM	90B14	
OUTPUT TORQUE	111.58	N.m
NOMINAL TORQUE	230.00	N.m
NOMINAL POWER	3.1	KW
SERVICE FACTOR	2.07	
DYNAMIC EFFICIENCY	0.96	

#### Oil Quantity (L)

B3/H1	B6/H4	B7/H3	B8/H2	V5/H5	V6/H6
0.9	1.5	0.75	1.4	1.95	1.15

#### Radial and Axial Loads



$n_2$ [min-1]	FA [N]	FR [N]
250	600	3000
100	800	4000
50	960	4800
15	1660	8300

**PX52AC...** Basic Gearbox  
Riduttore base

Gearbox weight **12.80 kg**  
peso riduttore

M. flanges	Kit code	øF	A
<b>71B5</b>	K023.4.041	160	234
<b>80/90B5</b>	K023.4.042	200	236
<b>100/112B5</b>	K023.4.043	250	245
<b>80B14</b>	K085.4.046	120	236
<b>90B14</b>	K085.4.045	140	236
<b>100/112B14</b>	K085.4.047	160	245

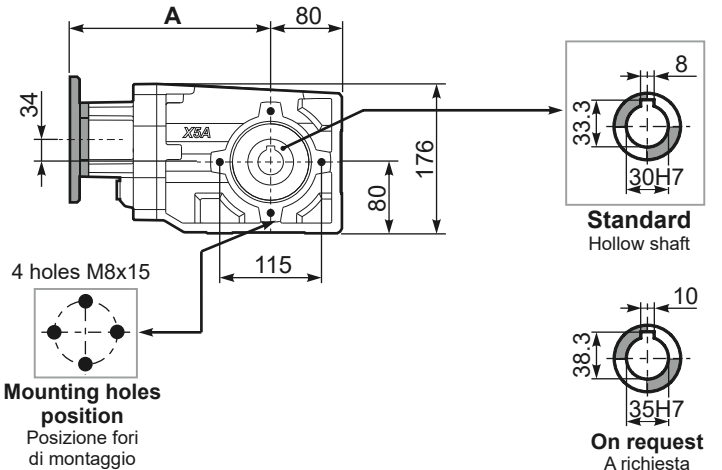
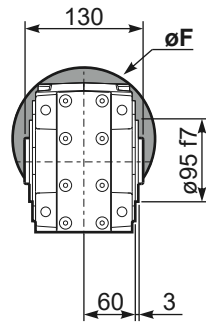

**PX52A...FB..** Feet  
Piedini

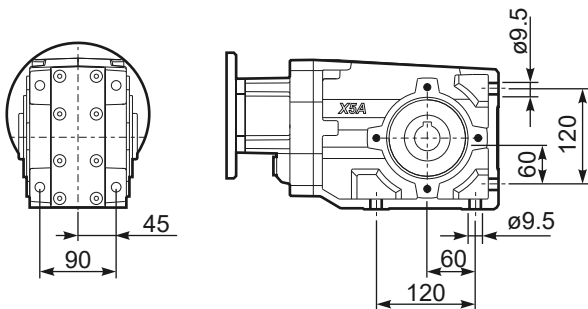

**PX52A...-F2..** Output flange  
Flangia uscita

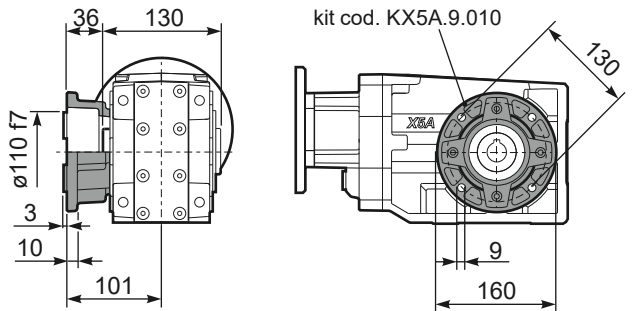

**PX52A...-F3..** Output flange  
Flangia uscita



**PX52A...-F4..** Output flange  
Flangia uscita

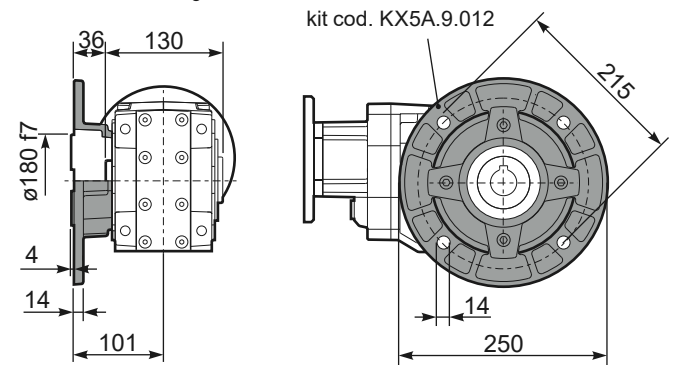

**RX52A...** Input shaft  
Albero in entrata



**PX52A...BR..** Reaction Arm  
Braccio di reazione



**PX52AA..** Single output shaft  
Albero semplice in uscita

