

| | | |
|--------------------|--------|-----|
| MODEL | X52A | |
| Ø OUTPUT SHAFT | 30 | mm |
| APPROXIMATE RATIO | 31 | |
| EXACT RATIO | 30.69 | |
| OUTPUT SPEED | 47 | RPM |
| EXACT OUTPUT SPEED | 48 | RPM |
| INPUT POWER | 1.10 | KW |
| INPUT ROTATION | 1400 | RPM |
| INPUT PAM | 90B5 | |
| OUTPUT TORQUE | 221.06 | N.m |
| NOMINAL TORQUE | 250.00 | N.m |
| NOMINAL POWER | 1.2 | KW |
| SERVICE FACTOR | 1.09 | |
| DYNAMIC EFFICIENCY | 0.96 | |

Oil Quantity (L)

| B3/H1 | B6/H4 | B7/H3 | B8/H2 | V5/H5 | V6/H6 |
|-------|-------|-------|-------|-------|-------|
| 0.9 | 1.5 | 0.75 | 1.4 | 1.95 | 1.15 |

Radial and Axial Loads



| n_2 [min-1] | F_A [N] | F_R [N] |
|---------------|-----------|-----------|
| 250 | 600 | 3000 |
| 100 | 800 | 4000 |
| 50 | 960 | 4800 |
| 15 | 1660 | 8300 |

PX52AC... Basic Gearbox
Riduttore base

Gearbox weight **12.80 kg**
peso riduttore

| M. flanges | Kit code | øF | A |
|-------------------|------------|-----|-----|
| 71B5 | K023.4.041 | 160 | 234 |
| 80/90B5 | K023.4.042 | 200 | 236 |
| 100/112B5 | K023.4.043 | 250 | 245 |
| 80B14 | K085.4.046 | 120 | 236 |
| 90B14 | K085.4.045 | 140 | 236 |
| 100/112B14 | K085.4.047 | 160 | 245 |



PX52A...FB.. Feet
Piedini



PX52A...-F2.. Output flange
Flangia uscita



PX52A...-F3.. Output flange
Flangia uscita



PX52A...-F4.. Output flange
Flangia uscita

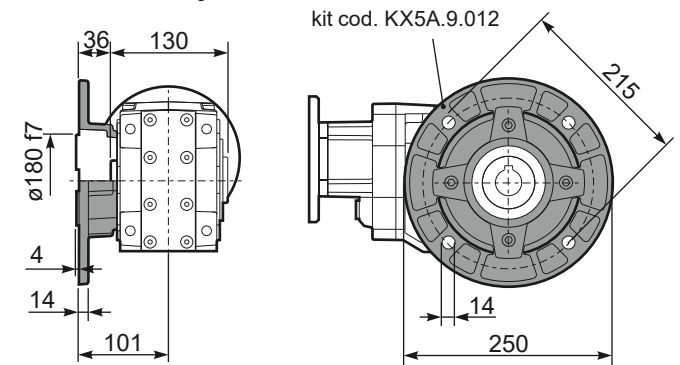

RX52A... Input shaft
Albero in entrata

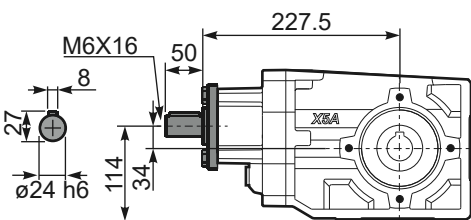

PX52A...BR.. Reaction Arm
Braccio di reazione



PX52AA.. Single output shaft
Albero semplice in uscita

