

MODEL	X63A	
Ø OUTPUT SHAFT	35	mm
APPROXIMATE RATIO	217	
EXACT RATIO	216.84	
OUTPUT SPEED	7	RPM
EXACT OUTPUT SPEED	7	RPM
INPUT POWER	0.25	KW
INPUT ROTATION	1400	RPM
INPUT PAM	71B5	
OUTPUT TORQUE	347.58	N.m
NOMINAL TORQUE	410.00	N.m
NOMINAL POWER	0.29	KW
SERVICE FACTOR	1.16	
DYNAMIC EFFICIENCY	0.94	

#### Oil Quantity (L)

B3/H1	B6/H4	B7/H3	B8/H2	V5/H5	V6/H6
1.8	1.8	1.05	1.7	2.6	1.65

#### Radial and Axial Loads



$n_2$ [min-1]	FA [N]	FR [N]
250	600	3000
100	780	3900
50	1140	5700
15	1660	8300

**PX63AC...** Basic Gearbox  
Riduttore base

Gearbox weight **15.98 kg**  
peso riduttore

M. flanges	Kit code	øF	A
<b>63B5</b>	K063.4.041	140	265
<b>71B5</b>	K063.4.042	160	263
<b>80/90B5</b>	K063.4.043	200	265
<b>71B14</b>	K063.4.047	105	263
<b>80B14</b>	K063.4.046	120	265
<b>90B14</b>	K063.4.041	140	265



**PX63A...FB..** Feet  
Piedini



**PX63A...-F2..** Output flange  
Flangia uscita



**PX63A...-F3..** Output flange  
Flangia uscita



**PX63A...-F4..** Output flange  
Flangia uscita



**RX63A...** Input shaft  
Albero in entrata



**PX63A...BR..** Reaction Arm  
Braccio di reazione

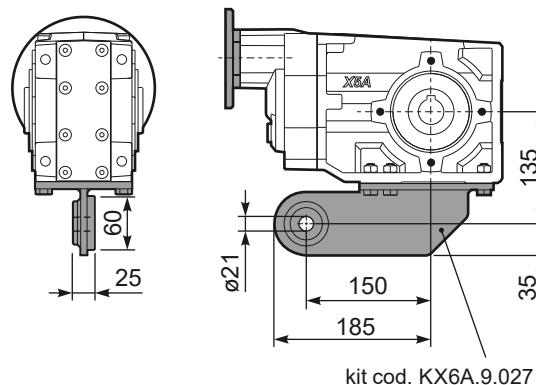

**PX63AA..** Single output shaft  
Albero semplice in uscita

