

MODEL	X63A	
Ø OUTPUT SHAFT	35	mm
APPROXIMATE RATIO	384	
EXACT RATIO	383.82	
OUTPUT SPEED	4	RPM
EXACT OUTPUT SPEED	4	RPM
INPUT POWER	0.18	KW
INPUT ROTATION	1400	RPM
INPUT PAM	63B5	
OUTPUT TORQUE	442.97	N.m
NOMINAL TORQUE	410.00	N.m
NOMINAL POWER	0.17	KW
SERVICE FACTOR	0.94	
DYNAMIC EFFICIENCY	0.94	

Oil Quantity (L)

B3/H1	B6/H4	B7/H3	B8/H2	V5/H5	V6/H6
1.8	1.8	1.05	1.7	2.6	1.65

Radial and Axial Loads



n_2 [min-1]	FA [N]	FR [N]
250	600	3000
100	780	3900
50	1140	5700
15	1660	8300

PX63AC... Basic Gearbox
Riduttore base

Gearbox weight **15.98 kg**
peso riduttore

M. flanges	Kit code	øF	A
63B5	K063.4.041	140	265
71B5	K063.4.042	160	263
80/90B5	K063.4.043	200	265
71B14	K063.4.047	105	263
80B14	K063.4.046	120	265
90B14	K063.4.041	140	265



PX63A...FB.. Feet
Piedini



PX63A...-F2.. Output flange
Flangia uscita



PX63A...-F3.. Output flange
Flangia uscita

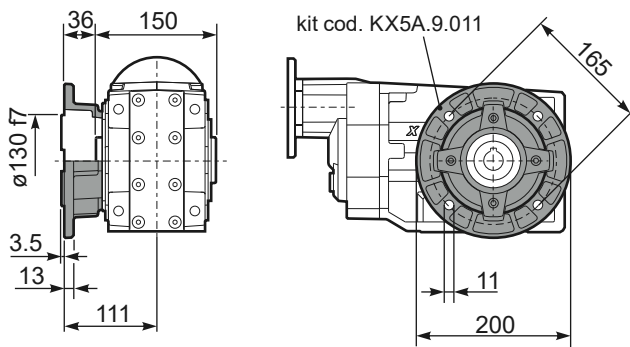

PX63A...-F4.. Output flange
Flangia uscita



RX63A... Input shaft
Albero in entrata



PX63A...BR.. Reaction Arm
Braccio di reazione

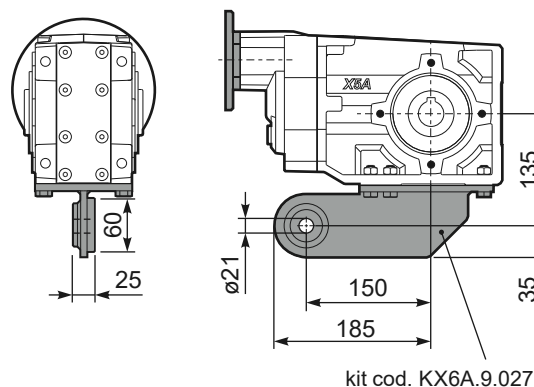

PX63AA.. Single output shaft
Albero semplice in uscita

