

Technical Data

Power 1.5kW

SUPPLY	AC 1PH 220-240V
INPUT CURRENT G*	7.7 A
INPUT CURRENT P	A
OUTPUT VOLTAGE	3PH 0~Vin V
OUTPUT CURRENT G	7.5 A
OUTPUT CURRENT P	A
IP	20
EMC FILTER C3	optional
EMC FILTER C2	optional
BRAKING UNIT	built-in



*G represents the constant torque and P represents the variable torque

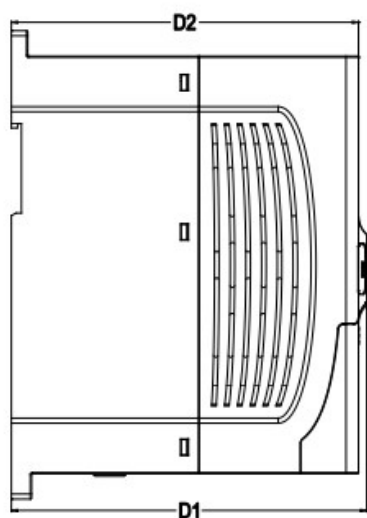
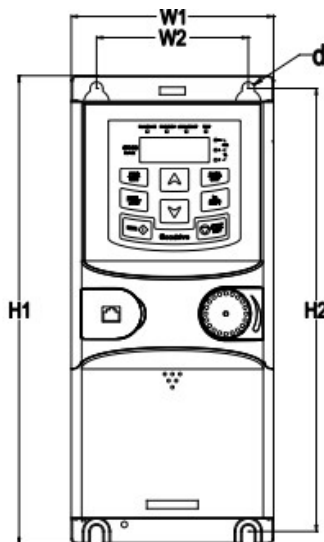

Installation dimensions

H1	185 mm
H2	175 mm
H3	- mm
W1	80 mm
W2	60 mm
W3	- mm
W4	- mm
D1	140.5 mm
D2	137.3 mm
Hole diameter	5 mm
Screw	M4

Control Diagram

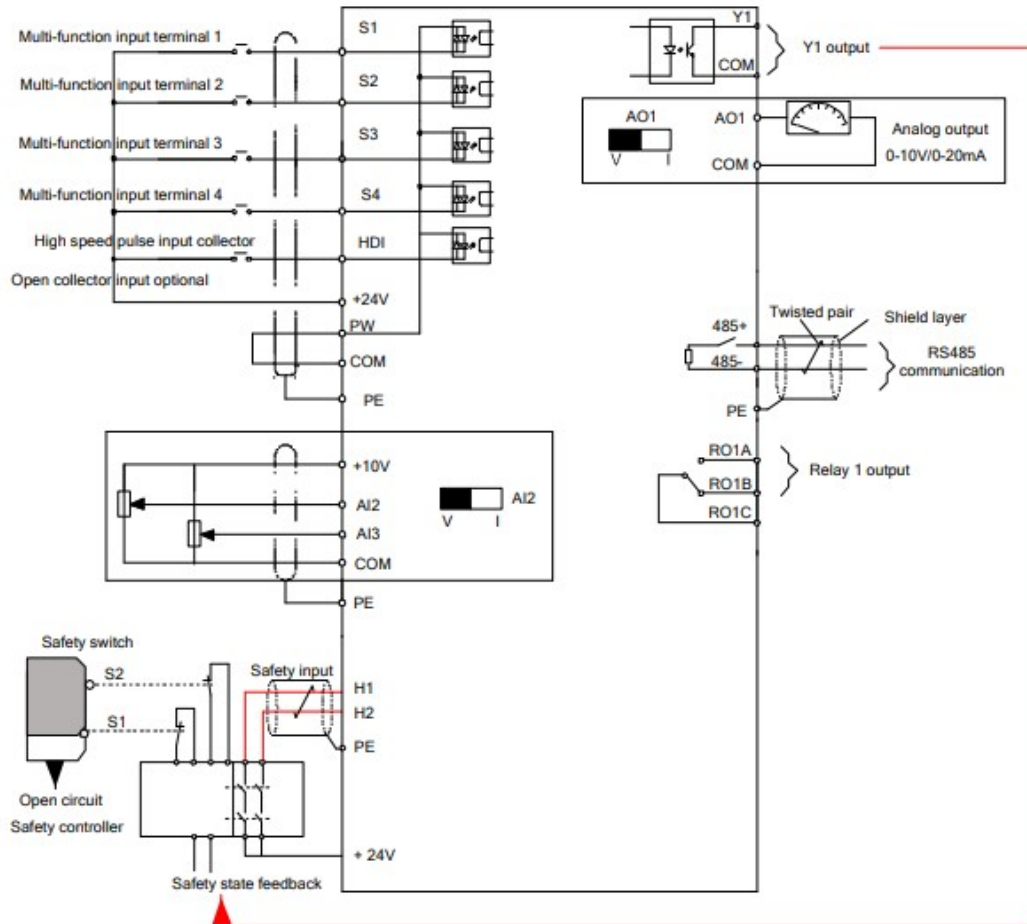

Packaging size

Height	242	mm
Width	130	mm
Depth	200	mm
Weight	1.3	Kg