

Technical Data

Power 37kW

SUPPLY	AC 3PH 380-440V
INPUT CURRENT G*	80 A
INPUT CURRENT P	94 A
OUTPUT VOLTAGE	3PH 0~Vin V
OUTPUT CURRENT G	75 A
OUTPUT CURRENT P	92 A
IP	20
EMC FILTER C3	built-in
EMC FILTER C2	optional
BRAKING UNIT	optional



*G represents the constant torque and P represents the variable torque

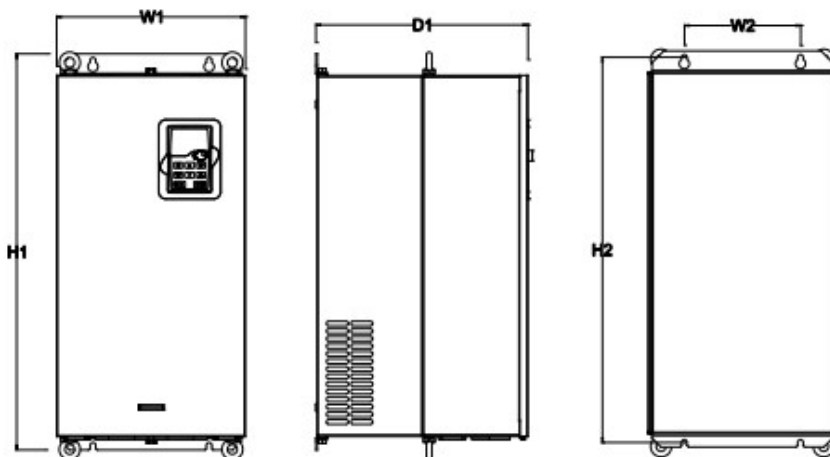

Installation dimensions

H1	555 mm
H2	540 mm
H3	- mm
W1	270 mm
W2	130 mm
W3	- mm
W4	- mm
D1	325 mm
D2	- mm
Hole diameter	7 mm
Screw	M6

Control Diagram

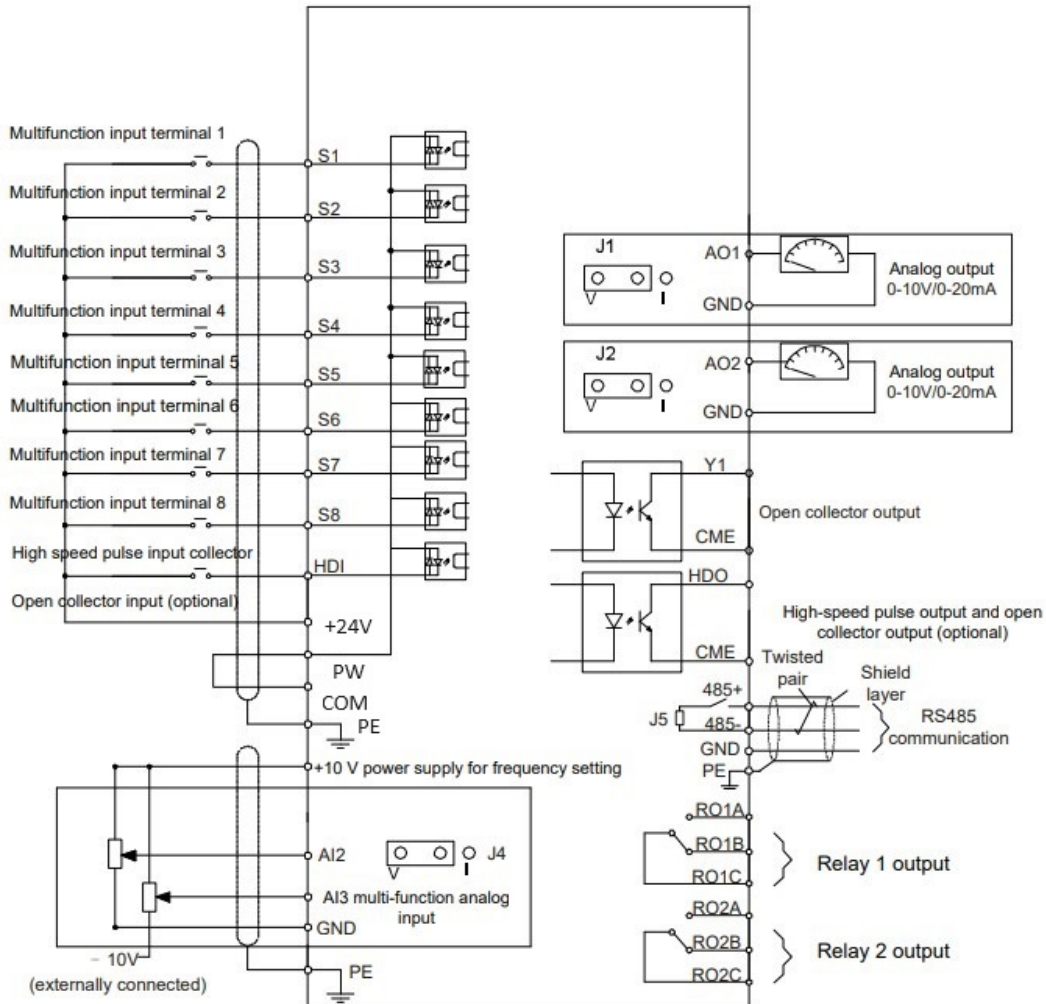

Packaging size

Height	695	mm
Width	410	mm
Depth	470	mm
Weight	32	Kg