

Technical Data

Power 220kW

SUPPLY	AC 3PH 380-440V
INPUT CURRENT G*	430 A
INPUT CURRENT P	460 A
OUTPUT VOLTAGE	3PH 0~Vin V
OUTPUT CURRENT G	425 A
OUTPUT CURRENT P	480 A
IP	20
EMC FILTER C3	built-in
EMC FILTER C2	optional
BRAKING UNIT	optional



*G represents the constant torque and P represents the variable torque

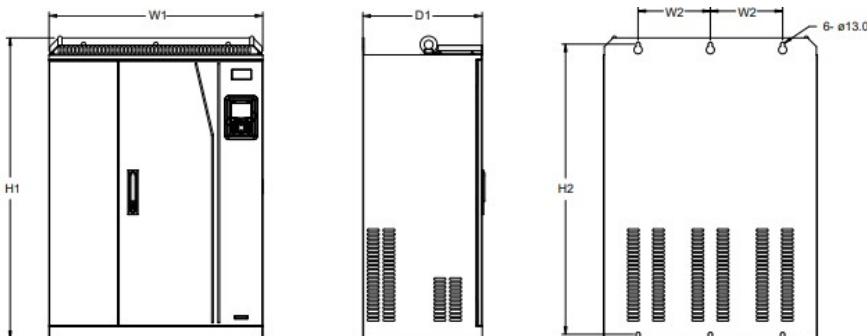

Installation dimensions

H1	960 mm
H2	926 mm
H3	- mm
W1	680 mm
W2	230 mm
W3	- mm
W4	- mm
D1	380 mm
D2	- mm
Hole diameter	13 mm
Screw	M12

Control Diagram

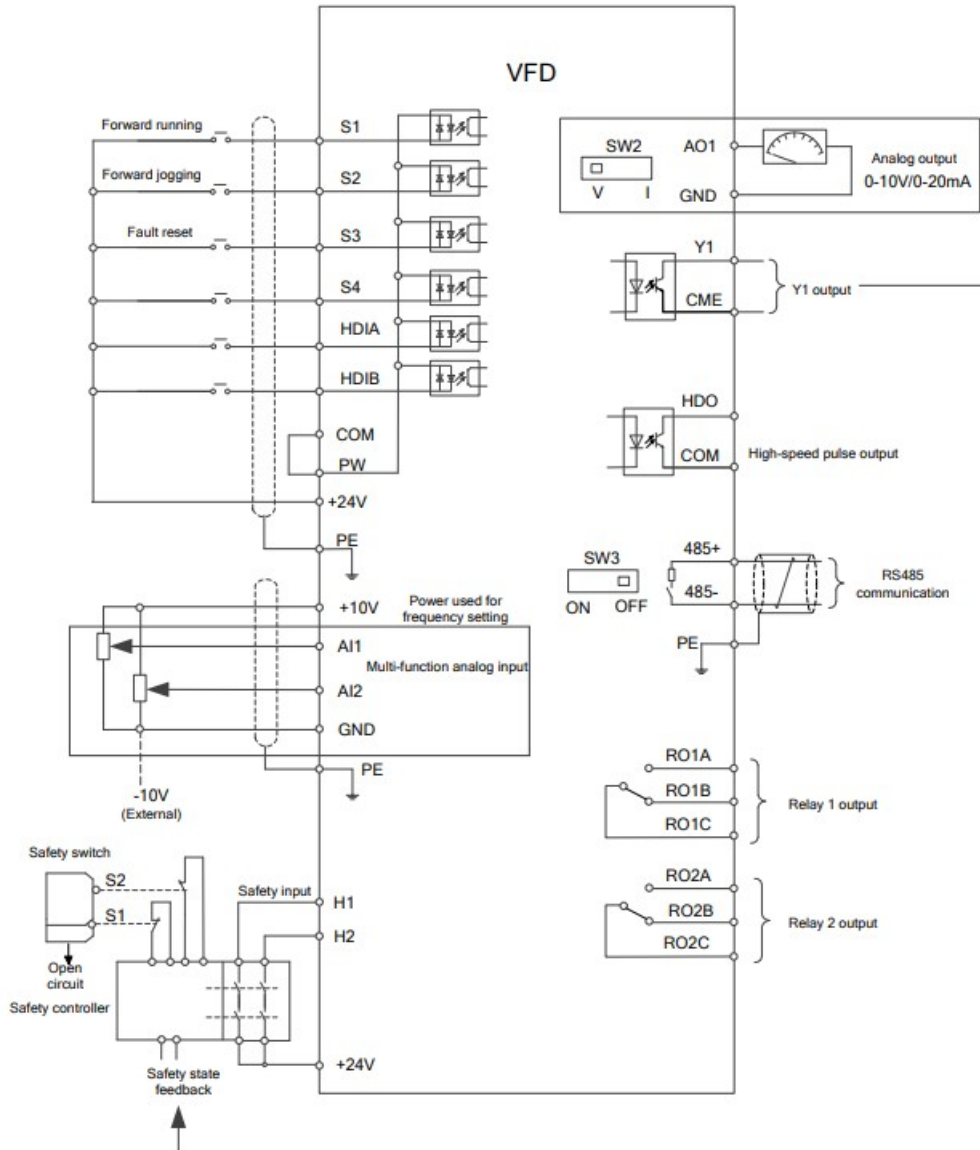

Packaging size

Height	1086	mm
Width	826	mm
Depth	595	mm
Weight	165	Kg