

MODEL	UMSG40	
Ø OUTPUT SHAFT	18	mm
APPROXIMATE RATIO	10	
EXACT RATIO	10.00	
OUTPUT SPEED	146	RPM
EXACT OUTPUT SPEED	146	RPM
INPUT POWER	0.25	KW
INPUT ROTATION	1400	RPM
INPUT PAM	71B14	
OUTPUT TORQUE	14.49	N.m
NOMINAL TORQUE	40.00	N.m
NOMINAL POWER	0.6899999999999999	KW
SERVICE FACTOR	2.76	
DYNAMIC EFFICIENCY	0.85	

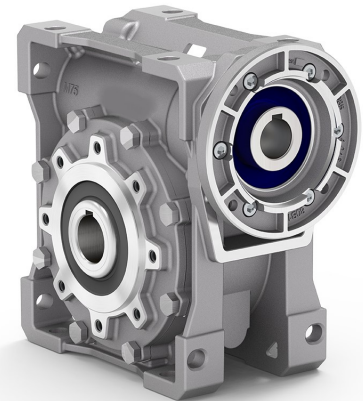

#### Oil Quantity (L)

B3/H1	B6/H4	B7/H3	B8/H2	V5/H5	V6/H6
0.1	0.1	0.1	0.1	0.1	0.1

#### Radial and Axial Loads

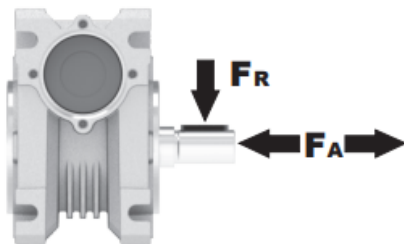

$n_2$ [min <sup>-1</sup> ]	FA [N]	FR [N]
200	180	900
100	220	1100
50	260	1400
15	400	2000

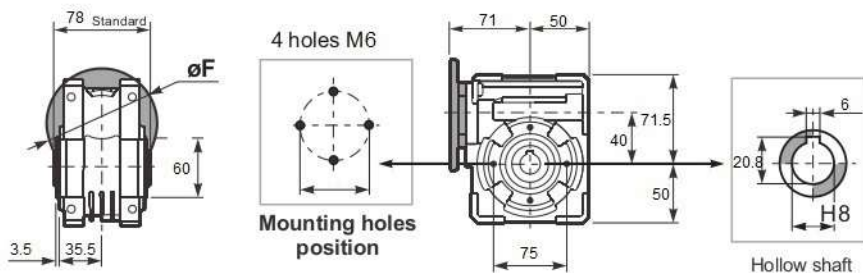

Square flange FA

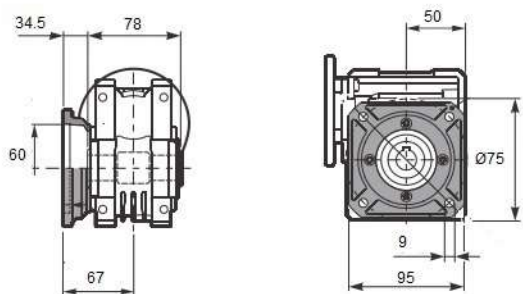

Square flange FB

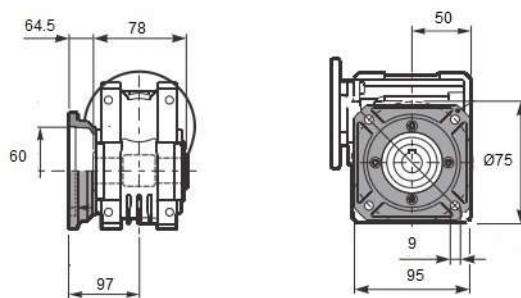

Feet

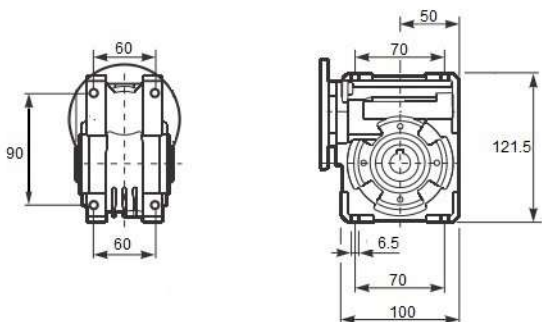

Reaction arm

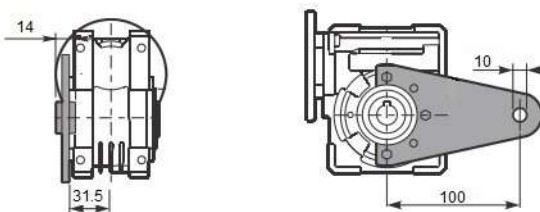

Single Shaft

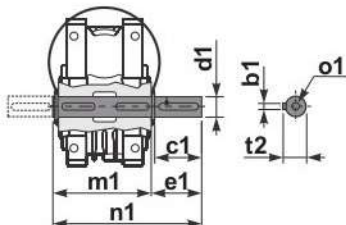

b1	c1	d1	e1	m1	n1	t2	o1
6	40	18	43	78	128	20.5	M6

1400 rpm	N2	Relação	P1	F5	P1n	M2	Rend.	Fr max	Veio		Flanges de entrada		
	rpm	i	kW		kW	Nm	%	N	Entrada	Saída	56	63	71
UMSG40	187	7,5	0,55	1,6	0,9	40	0,87	1315	14	18		B14/B5	B14/B5
	140	10	0,55	1,3	0,69	40	0,85	1447			B14/B5	B14/B5	
	93	15	0,55	0,9	0,48	39	0,82	1657			B14/B5	B14/B5	
	70	20	0,37	1,0	0,37	39	0,78	1824			B14/B5	B14/B5	
	56	25	0,25	1,2	0,3	38	0,75	1964			B14/B5	B14/B5	
	47	30	0,25	1,2	0,31	44	0,7	2087			B14/B5	B14/B5	
	35	40	0,25	0,9	0,23	41	0,65	2298			B14/B5	B14/B5	
	28	50	0,18	1,0	0,18	37	0,62	2475			B14/B5	B14/B5	
	23	60	0,12	1,3	0,15	35	0,58	2630	B14/B5	B14/B5			
	18	80	0,12	1,0	0,12	33	0,52	2895	B14/B5	B14/B5			
	14	100	0,09	1,0	0,09	29	0,47	3118	B14/B5	B14/B5			