

MODEL	UMSG90	
Ø OUTPUT SHAFT	35	mm
APPROXIMATE RATIO	25	
EXACT RATIO	25.00	
OUTPUT SPEED	58	RPM
EXACT OUTPUT SPEED	58	RPM
INPUT POWER	1.50	KW
INPUT ROTATION	1400	RPM
INPUT PAM	90B14	
OUTPUT TORQUE	209.74	N.m
NOMINAL TORQUE	335.59	N.m
NOMINAL POWER	2.4	KW
SERVICE FACTOR	1.60	
DYNAMIC EFFICIENCY	0.82	



Oil Quantity (L)

B3/H1	B6/H4	B7/H3	B8/H2	V5/H5	V6/H6
1	1	1	1	1	1

Radial and Axial Loads



n_2 [min ⁻¹]	FA [N]	FR [N]
200	500	2500
100	600	3000
50	800	4000
15	1160	5800



Square flange FA



Round flange FB



Feet

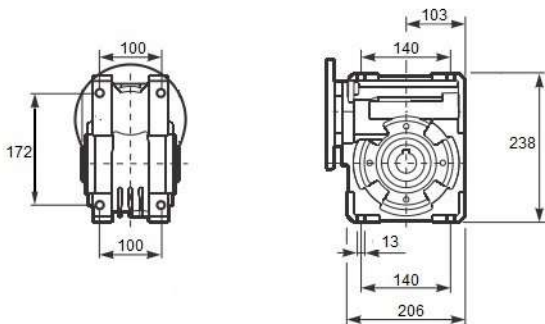

Reaction arm



Single Shaft



b1	c1	d1	e1	m1	n1	t2	o1
10	80	35	84.5	140	234	38	M12

1400 rpm	N2	Relação	P1	FS	P1n	M2	Rend.	Fr max	Veio		Flanges de entrada		
	rpm	i	kW		kW	Nm	%	N	Entrada	Saída	80	90	100/112
UMSG90	187	7,5	5,5	1,1	6,3	287	0,9	3081	28	35		B14/B5	B14/B5
	140	10	5,5	0,9	5,1	306	0,89	3391			B14/B5	B14/B5	
	93	15	4	1,0	4,1	357	0,86	3882			B14/B5	B14/B5	
	70	20	3	1,0	3,1	351	0,84	4273			B14/B5	B14/B5	
	56	25	2,2	1,1	2,4	332	0,82	4603			B14/B5	B14/B5	
	47	30	2,2	1,2	2,6	415	0,78	4891			B14/B5	B14/B5	
	35	40	1,5	1,2	1,8	363	0,75	5383	24	35	B14/B5	B14/B5	
	28	50	1,1	1,3	1,4	339	0,72	5799			B14/B5	B14/B5	
	23	60	1,1	1,0	1,1	307	0,69	6163			B14/B5	B14/B5	
	18	80	0,75	1,1	0,83	285	0,63	6783			B14/B5		
	14	100	0,55	1,2	0,67	270	0,59	7306	19		B14/B5		