

MODEL	UMSG150	
Ø OUTPUT SHAFT	50	mm
APPROXIMATE RATIO	15	
EXACT RATIO	15.00	
OUTPUT SPEED	97	RPM
EXACT OUTPUT SPEED	97	RPM
INPUT POWER	7.50	KW
INPUT ROTATION	1400	RPM
INPUT PAM	132B5	
OUTPUT TORQUE	675.27	N.m
NOMINAL TORQUE	1305.53	N.m
NOMINAL POWER	14.5	KW
SERVICE FACTOR	1.93	
DYNAMIC EFFICIENCY	0.88	



#### Oil Quantity (L)

B3/H1	B6/H4	B7/H3	B8/H2	V5/H5	V6/H6
7	5.1	5.1	5.4	7	5.1

#### Radial and Axial Loads



$n_2$ [min <sup>-1</sup> ]	FA [N]	FR [N]
200	1300	6500
100	1640	8200
50	2120	10600
15	3300	16500

Basic wormbox



Square flange FA



Single Shaft

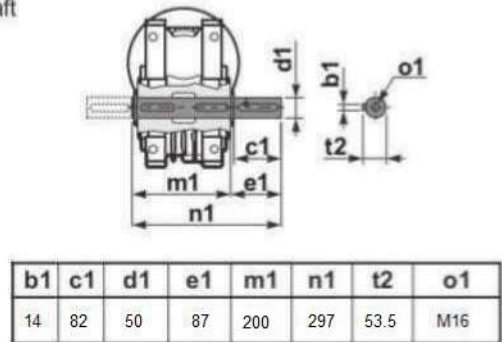

Feet

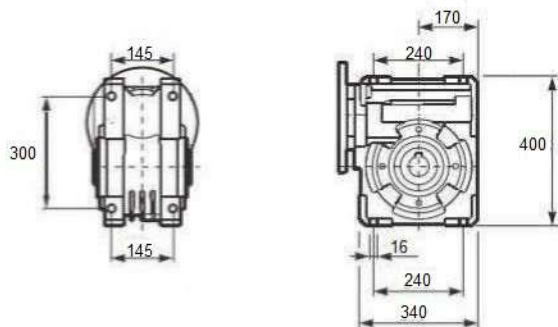

Reaction arm

