

Technical Data Sheet  
Gearbox  
WORM GEARBOX SQUARE DESIGN



MODEL	Q11	
Ø OUTPUT SHAFT	42	mm
APPROXIMATE RATIO	100	
EXACT RATIO	99.00	
OUTPUT SPEED	15	RPM
EXACT OUTPUT SPEED	15	RPM
INPUT POWER	0.75	KW
INPUT ROTATION	1400	RPM
INPUT PAM	80B14	
OUTPUT TORQUE	303.87	N.m
NOMINAL TORQUE	483.00	N.m
NOMINAL POWER	1.2	KW
SERVICE FACTOR	1.60	
DYNAMIC EFFICIENCY	0.60	



Oil Quantity (L)

B3/H1	B6/H4	B7/H3	B8/H2	V5/H5	V6/H6
1.9	1.35	1.35	2	2	2

Radial and Axial Loads



$n_2$ [min-1]	FA [N]	FR [N]
200	600	2900
100	750	3600
50	920	4600
15	1400	7000

Universal Motors S.A.  
Rua Comendador Brandão, 484  
4495-375 Póvoa de Varzim  
[geral@universalmotors.pt](mailto:geral@universalmotors.pt)  
TEL.: 252 299 080

Universal Motors UK, Ltd  
Unit E2, Meltham Mills Road  
West Yorkshire HD9 4AR  
[enquiries@universalmotors-group.co.uk](mailto:enquiries@universalmotors-group.co.uk)  
TEL.: +44(0) 1484660222

Universal Motors SL  
C/La Habana n.6 nave 4 PI Camporoso  
28806 Alcala de Henares  
[info@universalmotors-group.es](mailto:info@universalmotors-group.es)  
TEL.: 918 864 213

**PQ11FB...** Basic wormbox  
Riduttore base

Gearbox weight  
peso riduttore **35.0 kg**

M. flanges	Kit code	øF	A
71B5	K023.4.041	160	136
80/90B5	K023.4.042	200	138
100/112B5	K023.4.043	250	147
132B5	-	300	187
80B14	K085.4.046	120	138
90B14	K085.4.045	140	138
100/112B14	K023.4.041	160	136
132B14	-	200	187



**PQ11FC...** Output flange  
Flangia uscita

**PQ11F1...** Output flange  
Flangia uscita



type B	øD	E	G	L	N	O	P	Q	kit code
FC	170 <sup>+0.083</sup> / <sub>+0.043</sub>	11	16.5	131.5	54	230	270	13	① K110.9.010 ② -
FL	170 <sup>+0.083</sup> / <sub>+0.043</sub>	11	16.5	179.5	102	230	270	13	① K110.9.011 ② -

type S	øD	E	G	L	N	O	P	Q	kit code
F1	180 <sup>+0.040</sup> / <sub>0</sub>	5	18	150	72.5	215	250	15	① KS110.9.014 ② -
F3	180 <sup>+0.040</sup> / <sub>0</sub>	5	18	130	52.5	215	250	15	① KS110.9.013 ② -

**PQ11FB...** Feet  
Piedini

**PQ11BR...** Reaction arm  
Braccio di reazione

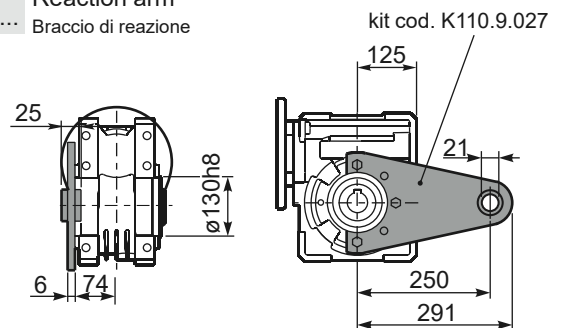

**RQ11FB...** Input shaft  
Albero in entrata

**PQ11.....S...** Single Shaft  
Albero lento semplice

**PQ11.....D...** Double Shaft  
Albero lento bisp.

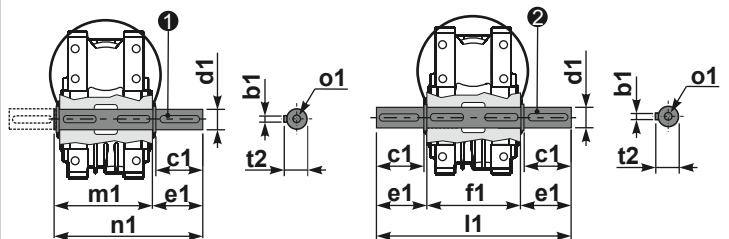
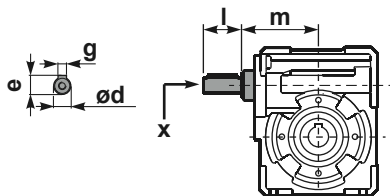

① kit cod. K110.5.028 type B    ② kit cod. K110.5.029 type B

	ød	e	g	l	m	x	kit code
type B	25 h6	28	8	50	131.5	M8x20	① K085.5.007 PAM90 ② K085.5.008 PAM100
type S	24 h6	27	8	50	131.5	M8x20	① KS085.5.009 PAM90 ② KS085.5.011 PAM100

	b1	c1	d1	e1	f1	l1	m1	n1	t2	o1
type B	12	75	42 <sup>-0.005</sup> / <sub>-0.020</sub>	96.5	155	348	163.5	260	45	M12x32
type S	-	-	-	-	-	-	-	-	-	-