

MODELO	X22S	
Ø EJE DE SALIDA	20	mm
RELACIÓN APROXIMADA	10	
RELACIÓN EXACTA	9.58	
VELOCIDAD DE SALIDA	146	RPM
VELOCIDAD DE SALIDA EXACTA	152	RPM
POTENCIA DE ENTRADA	0.18	KW
ROTACIÓN DE ENTRADA	1400	RPM
PAM DE ENTRADA	63B14	
PAR DE SALIDA	11.29	N.m
PAR NOMINAL	40.00	N.m
POTENCIA NOMINAL	0.64	KW
FACTOR DE SERVICIO	3.56	
EFICIENCIA DINÁMICA	0.96	

Cantidad de Aceite (L)

B3/H1	B6/H4	B7/H3	B8/H2	V5/H5	V6/H6
0.25	0.25	0.25	0.25	0.43	0.31

Cargas Radiales y Axiales



n_2 [min-1]	F_A [N]	F_R [N]
400	360	1800
150	420	2100
75	440	2200
25	440	2200

PX22SC... Basic Gearbox
Riduttore base

Gearbox weight
peso riduttore **3.70 kg**

M. flanges	Kit code	øF	A
63B5	K050.4.041	138	154.5
71B5	K050.4.042	160	152
56B14	KC40.4.049	80	152
63B14	K050.4.047	90	154.5
71B14	K050.4.045	105	152

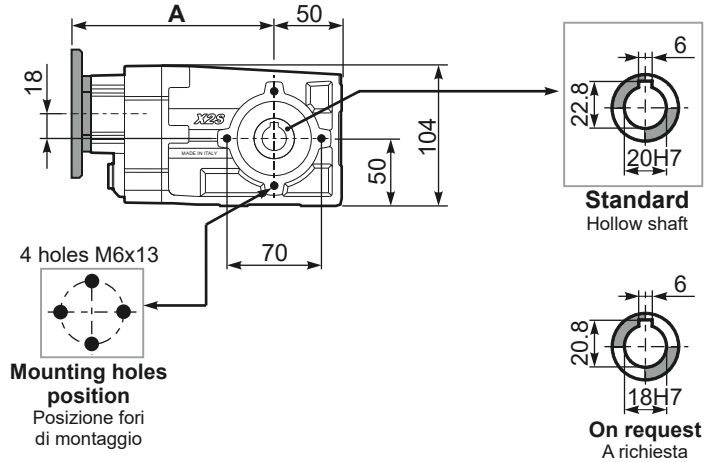
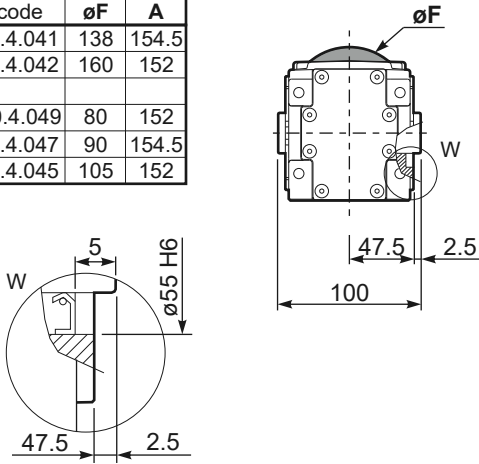

PX22S...**FB**.. Feet
Piedini



PX22S...**-F1**.. Output flange
Flangia uscita



PX22S**A**.. Single output shaft
Albero semplice in uscita



PX22S...**BR**.. Reaction Arm
Braccio di reazione



RX22S.. Input shaft
Albero in entrata

