

| | | |
|----------------------------|-------|-----|
| MODELO | X22S | |
| Ø EJE DE SALIDA | 20 | mm |
| RELACIÓN APROXIMADA | 16 | |
| RELACIÓN EXACTA | 15.79 | |
| VELOCIDAD DE SALIDA | 91 | RPM |
| VELOCIDAD DE SALIDA EXACTA | 92 | RPM |
| POTENCIA DE ENTRADA | 0.55 | KW |
| ROTACIÓN DE ENTRADA | 1400 | RPM |
| PAM DE ENTRADA | 71B5 | |
| PAR DE SALIDA | 56.87 | N.m |
| PAR NOMINAL | 45.00 | N.m |
| POTENCIA NOMINAL | 0.44 | KW |
| FACTOR DE SERVICIO | 0.80 | |
| EFICIENCIA DINÁMICA | 0.96 | |

Cantidad de Aceite (L)

| B3/H1 | B6/H4 | B7/H3 | B8/H2 | V5/H5 | V6/H6 |
|-------|-------|-------|-------|-------|-------|
| 0.25 | 0.25 | 0.25 | 0.25 | 0.43 | 0.31 |

Cargas Radiales y Axiales



| n_2 [min-1] | F_A [N] | F_R [N] |
|---------------|-----------|-----------|
| 400 | 360 | 1800 |
| 150 | 420 | 2100 |
| 75 | 440 | 2200 |
| 25 | 440 | 2200 |

PX22SC... Basic Gearbox
Riduttore base

Gearbox weight
peso riduttore **3.70 kg**

| M. flanges | Kit code | øF | A |
|--------------|------------|-----|-------|
| 63B5 | K050.4.041 | 138 | 154.5 |
| 71B5 | K050.4.042 | 160 | 152 |
| 56B14 | KC40.4.049 | 80 | 152 |
| 63B14 | K050.4.047 | 90 | 154.5 |
| 71B14 | K050.4.045 | 105 | 152 |

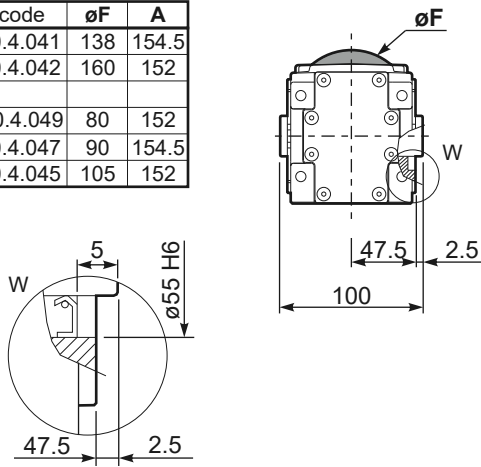

PX22S...**FB**.. Feet
Piedini



PX22S...**-F1**.. Output flange
Flangia uscita



PX22S**A**.. Single output shaft
Albero semplice in uscita



PX22S...**BR**.. Reaction Arm
Braccio di reazione

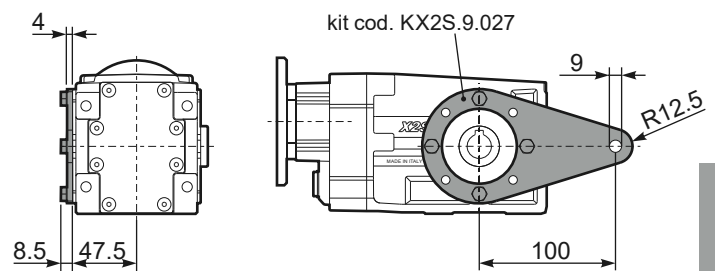

RX22S.. Input shaft
Albero in entrata

