

MODELO	X22S	
Ø EJE DE SALIDA	20	mm
RELACIÓN APROXIMADA	22	
RELACIÓN EXACTA	21.93	
VELOCIDAD DE SALIDA	66	RPM
VELOCIDAD DE SALIDA EXACTA	67	RPM
POTENCIA DE ENTRADA	0.12	KW
ROTACIÓN DE ENTRADA	1400	RPM
PAM DE ENTRADA	63B5	
PAR DE SALIDA	17.23	N.m
PAR NOMINAL	50.00	N.m
POTENCIA NOMINAL	0.35	KW
FACTOR DE SERVICIO	2.92	
EFICIENCIA DINÁMICA	0.96	

Cantidad de Aceite (L)

B3/H1	B6/H4	B7/H3	B8/H2	V5/H5	V6/H6
0.25	0.25	0.25	0.25	0.43	0.31

Cargas Radiales y Axiales



$n_2$ [min-1]	$F_A$ [N]	$F_R$ [N]
400	360	1800
150	420	2100
75	440	2200
25	440	2200

**P**X22SC... Basic Gearbox  
Riduttore base

Gearbox weight  
peso riduttore **3.70 kg**

M. flanges	Kit code	øF	A
<b>63B5</b>	K050.4.041	138	154.5
<b>71B5</b>	K050.4.042	160	152
<b>56B14</b>	KC40.4.049	80	152
<b>63B14</b>	K050.4.047	90	154.5
<b>71B14</b>	K050.4.045	105	152

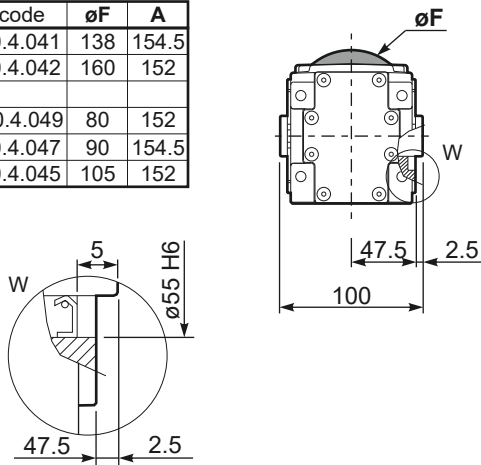

PX22S...**FB**.. Feet  
Piedini



PX22S...**-F1**.. Output flange  
Flangia uscita



PX22S**A**.. Single output shaft  
Albero semplice in uscita



PX22S...**BR**.. Reaction Arm  
Braccio di reazione

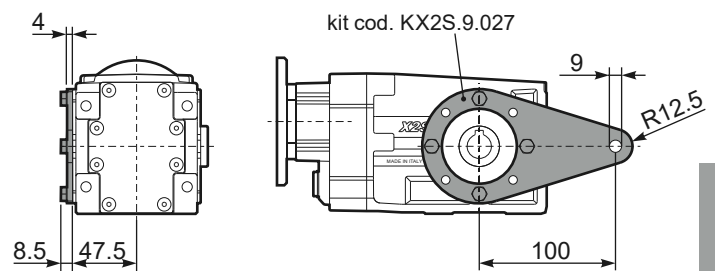

**R**X22S.. Input shaft  
Albero in entrata

