

MODELO	X33S	
Ø EJE DE SALIDA	20	mm
RELACIÓN APROXIMADA	60	
RELACIÓN EXACTA	60.31	
VELOCIDAD DE SALIDA	24	RPM
VELOCIDAD DE SALIDA EXACTA	24	RPM
POTENCIA DE ENTRADA	0.12	KW
ROTACIÓN DE ENTRADA	1400	RPM
PAM DE ENTRADA	63B5	
PAR DE SALIDA	46.40	N.m
PAR NOMINAL	100.00	N.m
POTENCIA NOMINAL	0.26	KW
FACTOR DE SERVICIO	2.17	
EFICIENCIA DINÁMICA	0.94	

Cantidad de Aceite (L)

B3/H1	B6/H4	B7/H3	B8/H2	V5/H5	V6/H6
0.7	0.65	0.4	0.65	0.95	0.65

Cargas Radiales y Axiales



n_2 [min-1]	F_A [N]	F_R [N]
250	400	2000
100	500	2500
50	560	2800
15	560	2800

PX33SC... Basic Gearbox
Riduttore base

Gearbox weight
peso riduttore **6.55 kg**

M. flanges	Kit code	øF	A
63B5	K050.4.041	138	189.5
71B5	K050.4.042	160	187
56B14	KC40.4.049	80	187
63B14	K050.4.047	90	189.5
71B14	K050.4.045	105	187



4 holes M8x15
Mounting holes position
Posizione fori di montaggio

PX33S...FB.. Feet
Piedini

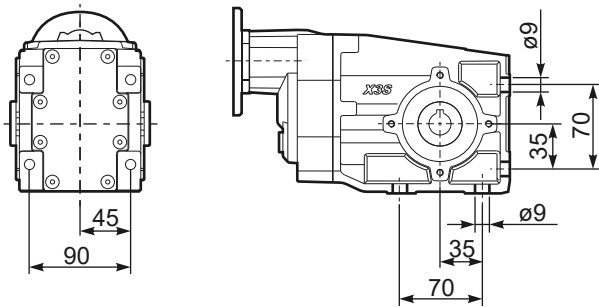

PX33S...-F1.. Output flange
Flangia uscita



PX33S...-F2.. Output flange
Flangia uscita



PX33S...BR.. Reaction Arm
Braccio di reazione



RX33S... Input shaft
Albero in entrata

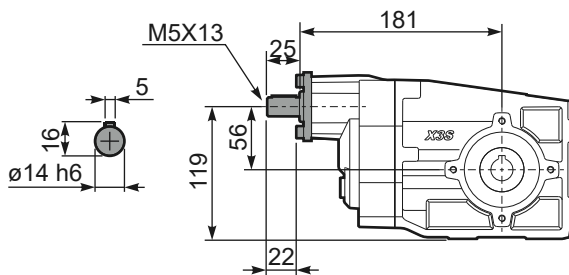

PX33SA.. Single output shaft
Albero semplice in uscita



d1	b1	c1	e1	m1	n1	t2	o1	1 kit code
ø20 k6	6	37.5	40	120	160	22.5	M8x20	KX2S.5.028
ø25 ^{-0.005} _{-0.020}	8	60	63.2	126.8	190	28	M8x20	K063.5.028