

MODELO	X42A	
Ø EJE DE SALIDA	25	mm
RELACIÓN APROXIMADA	38	
RELACIÓN EXACTA	38.12	
VELOCIDAD DE SALIDA	38	RPM
VELOCIDAD DE SALIDA EXACTA	38	RPM
POTENCIA DE ENTRADA	0.25	KW
ROTACIÓN DE ENTRADA	1400	RPM
PAM DE ENTRADA	71B14	
PAR DE SALIDA	62.40	N.m
PAR NOMINAL	150.00	N.m
POTENCIA NOMINAL	0.6	KW
FACTOR DE SERVICIO	2.40	
EFICIENCIA DINÁMICA	0.96	

Cantidad de Aceite (L)

B3/H1	B6/H4	B7/H3	B8/H2	V5/H5	V6/H6
0.6	0.75	0.5	0.7	1.1	0.6

Cargas Radiales y Axiales



n_2 [min-1]	F_A [N]	F_R [N]
250	500	2500
100	700	3500
50	960	4800
15	960	4800

PX42AC... Basic Gearbox
Riduttore base

Gearbox weight
peso riduttore **7.82 kg**

M. flanges	Kit code	øF	A
63B5	K063.4.041	140	199.5
71B5	K063.4.042	160	197.5
80/90B5	K063.4.043	200	199.5
100/112B5	KC40.4.043	250	214.3
71B14	K063.4.047	105	197.5
80B14	K063.4.046	120	199.5
90B14	K063.4.041	140	199.5
100/112B14	KC40.4.041	160	214.5



PX42A...FB.. Feet
Piedini



PX42A...-F2.. Output flange
Flangia uscita



PX42A...-F3.. Output flange
Flangia uscita



PX42A...BR.. Reaction Arm
Braccio di reazione

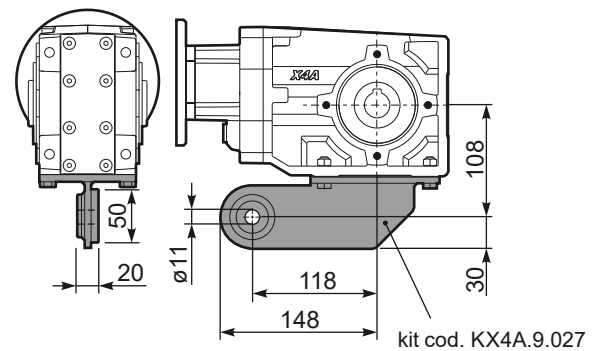

RX42A... Input shaft
Albero in entrata



PX42AA.. Single output shaft
Albero semplice in uscita

