

MODELO	X42A	
Ø EJE DE SALIDA	25	mm
RELACIÓN APROXIMADA	23	
RELACIÓN EXACTA	23.47	
VELOCIDAD DE SALIDA	63	RPM
VELOCIDAD DE SALIDA EXACTA	62	RPM
POTENCIA DE ENTRADA	0.37	KW
ROTACIÓN DE ENTRADA	1400	RPM
PAM DE ENTRADA	71B5	
PAR DE SALIDA	56.86	N.m
PAR NOMINAL	150.00	N.m
POTENCIA NOMINAL	0.98	KW
FACTOR DE SERVICIO	2.65	
EFICIENCIA DINÁMICA	0.96	

Cantidad de Aceite (L)

B3/H1	B6/H4	B7/H3	B8/H2	V5/H5	V6/H6
0.6	0.75	0.5	0.7	1.1	0.6

Cargas Radiales y Axiales



$n_2$ [min-1]	$F_A$ [N]	$F_R$ [N]
250	500	2500
100	700	3500
50	960	4800
15	960	4800

**PX42AC...** Basic Gearbox  
Riduttore base

Gearbox weight **7.82 kg**  
peso riduttore

M. flanges	Kit code	øF	A
<b>63B5</b>	K063.4.041	140	199.5
<b>71B5</b>	K063.4.042	160	197.5
<b>80/90B5</b>	K063.4.043	200	199.5
<b>100/112B5</b>	KC40.4.043	250	214.3
<b>71B14</b>	K063.4.047	105	197.5
<b>80B14</b>	K063.4.046	120	199.5
<b>90B14</b>	K063.4.041	140	199.5
<b>100/112B14</b>	KC40.4.041	160	214.5

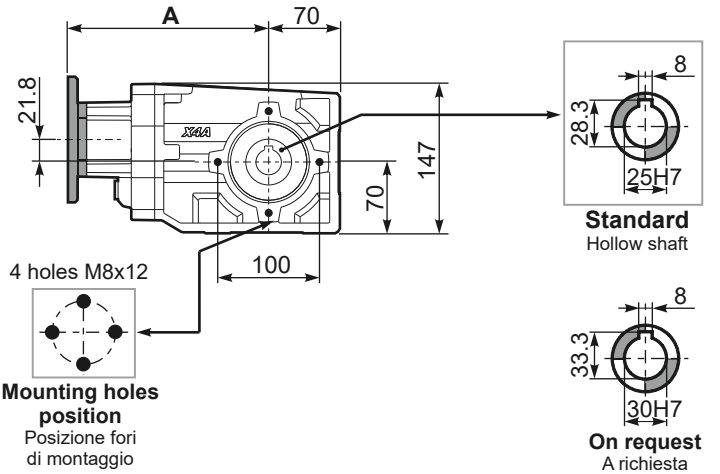

**PX42A...FB..** Feet  
Piedini



**PX42A...-F2..** Output flange  
Flangia uscita



**PX42A...-F3..** Output flange  
Flangia uscita



**PX42A...BR..** Reaction Arm  
Braccio di reazione



**RX42A...** Input shaft  
Albero in entrata



**PX42AA..** Single output shaft  
Albero semplice in uscita

