

MODELO	X42A	
Ø EJE DE SALIDA	25	mm
RELACIÓN APROXIMADA	50	
RELACIÓN EXACTA	50.34	
VELOCIDAD DE SALIDA	29	RPM
VELOCIDAD DE SALIDA EXACTA	29	RPM
POTENCIA DE ENTRADA	0.18	KW
ROTACIÓN DE ENTRADA	1400	RPM
PAM DE ENTRADA	63B5	
PAR DE SALIDA	59.33	N.m
PAR NOMINAL	131.00	N.m
POTENCIA NOMINAL	0.4	KW
FACTOR DE SERVICIO	2.22	
EFICIENCIA DINÁMICA	0.96	

Cantidad de Aceite (L)

B3/H1	B6/H4	B7/H3	B8/H2	V5/H5	V6/H6
0.6	0.75	0.5	0.7	1.1	0.6

Cargas Radiales y Axiales



$n_2$ [min-1]	$F_A$ [N]	$F_R$ [N]
250	500	2500
100	700	3500
50	960	4800
15	960	4800

**PX42AC...** Basic Gearbox  
Riduttore base

Gearbox weight **7.82 kg**  
peso riduttore

M. flanges	Kit code	øF	A
<b>63B5</b>	K063.4.041	140	199.5
<b>71B5</b>	K063.4.042	160	197.5
<b>80/90B5</b>	K063.4.043	200	199.5
<b>100/112B5</b>	KC40.4.043	250	214.3
<b>71B14</b>	K063.4.047	105	197.5
<b>80B14</b>	K063.4.046	120	199.5
<b>90B14</b>	K063.4.041	140	199.5
<b>100/112B14</b>	KC40.4.041	160	214.5

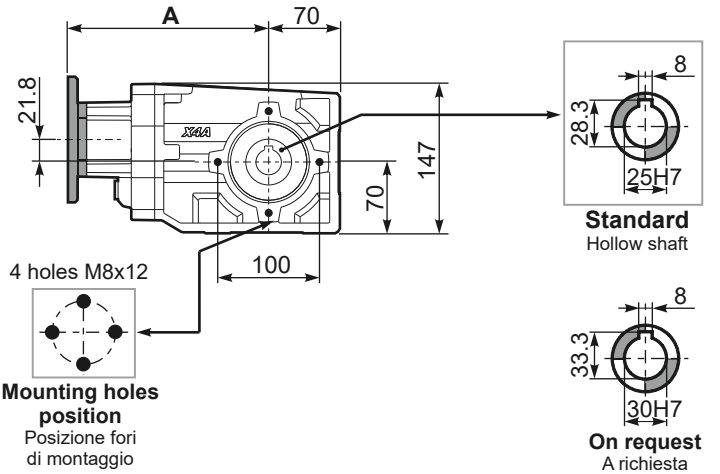

**PX42A...FB..** Feet  
Piedini

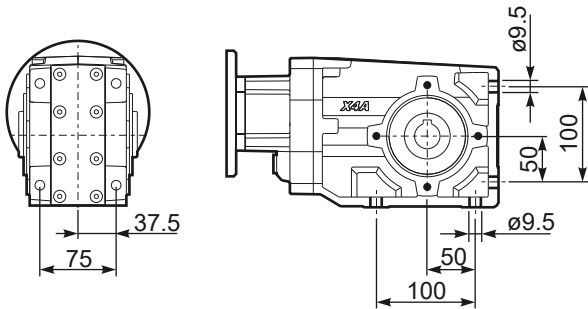

**PX42A...-F2..** Output flange  
Flangia uscita



**PX42A...-F3..** Output flange  
Flangia uscita



**PX42A...BR..** Reaction Arm  
Braccio di reazione



**RX42A...** Input shaft  
Albero in entrata



**PX42AA..** Single output shaft  
Albero semplice in uscita

