

MODELO	X52A	
Ø EJE DE SALIDA	30	mm
RELACIÓN APROXIMADA	11	
RELACIÓN EXACTA	11.36	
VELOCIDAD DE SALIDA	133	RPM
VELOCIDAD DE SALIDA EXACTA	129	RPM
POTENCIA DE ENTRADA	3.00	KW
ROTACIÓN DE ENTRADA	1400	RPM
PAM DE ENTRADA	100B14	
PAR DE SALIDA	223.16	N.m
PAR NOMINAL	230.00	N.m
POTENCIA NOMINAL	3.1	KW
FACTOR DE SERVICIO	1.03	
EFICIENCIA DINÁMICA	0.96	

Cantidad de Aceite (L)

B3/H1	B6/H4	B7/H3	B8/H2	V5/H5	V6/H6
0.9	1.5	0.75	1.4	1.95	1.15

Cargas Radiales y Axiales



$n_2$ [min-1]	$F_A$ [N]	$F_R$ [N]
250	600	3000
100	800	4000
50	960	4800
15	1660	8300

**PX52AC...** Basic Gearbox  
Riduttore base

Gearbox weight **12.80 kg**  
peso riduttore

M. flanges	Kit code	øF	A
<b>71B5</b>	K023.4.041	160	234
<b>80/90B5</b>	K023.4.042	200	236
<b>100/112B5</b>	K023.4.043	250	245
<b>80B14</b>	K085.4.046	120	236
<b>90B14</b>	K085.4.045	140	236
<b>100/112B14</b>	K085.4.047	160	245



**PX52A...FB..** Feet  
Piedini



**PX52A...-F2..** Output flange  
Flangia uscita

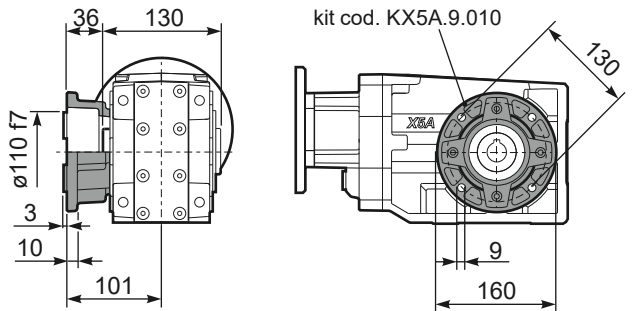

**PX52A...-F3..** Output flange  
Flangia uscita



**PX52A...-F4..** Output flange  
Flangia uscita

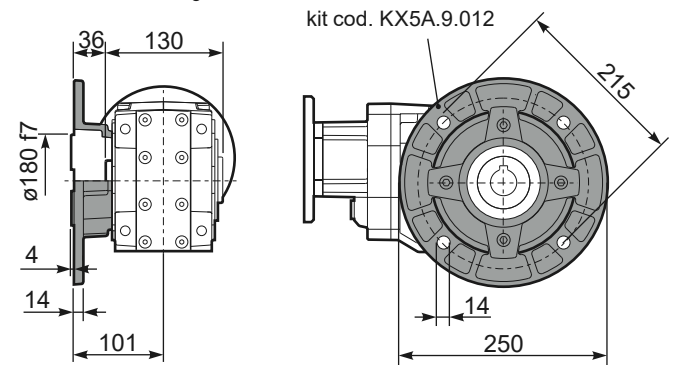

**RX52A...** Input shaft  
Albero in entrata



**PX52A...BR..** Reaction Arm  
Braccio di reazione



**PX52AA..** Single output shaft  
Albero semplice in uscita

