

MODELO	X52A	
Ø EJE DE SALIDA	30	mm
RELACIÓN APROXIMADA	6	
RELACIÓN EXACTA	6.03	
VELOCIDAD DE SALIDA	243	RPM
VELOCIDAD DE SALIDA EXACTA	242	RPM
POTENCIA DE ENTRADA	3.00	KW
ROTACIÓN DE ENTRADA	1400	RPM
PAM DE ENTRADA	100B5	
PAR DE SALIDA	118.45	N.m
PAR NOMINAL	135.00	N.m
POTENCIA NOMINAL	3.4	KW
FACTOR DE SERVICIO	1.13	
EFICIENCIA DINÁMICA	0.96	

Cantidad de Aceite (L)

B3/H1	B6/H4	B7/H3	B8/H2	V5/H5	V6/H6
0.9	1.5	0.75	1.4	1.95	1.15

Cargas Radiales y Axiales



n_2 [min-1]	F_A [N]	F_R [N]
250	600	3000
100	800	4000
50	960	4800
15	1660	8300

PX52AC... Basic Gearbox
Riduttore base

Gearbox weight **12.80 kg**
peso riduttore

M. flanges	Kit code	øF	A
71B5	K023.4.041	160	234
80/90B5	K023.4.042	200	236
100/112B5	K023.4.043	250	245
80B14	K085.4.046	120	236
90B14	K085.4.045	140	236
100/112B14	K085.4.047	160	245



PX52A...FB.. Feet
Piedini

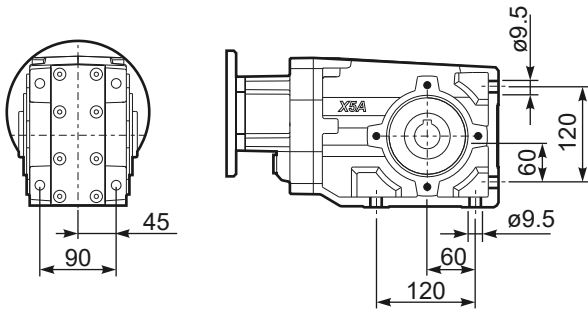

PX52A...-F2.. Output flange
Flangia uscita

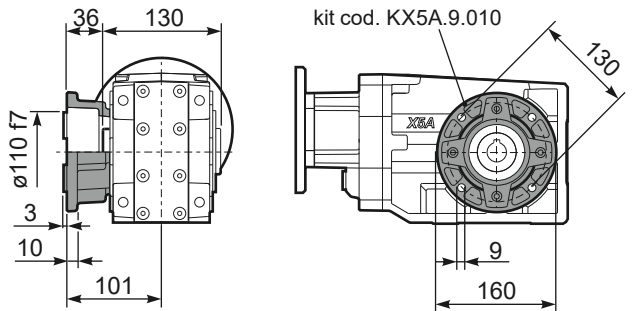

PX52A...-F3.. Output flange
Flangia uscita



PX52A...-F4.. Output flange
Flangia uscita

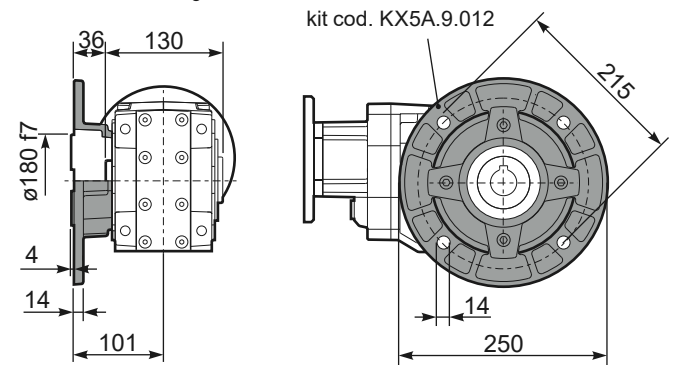

RX52A... Input shaft
Albero in entrata



PX52A...BR.. Reaction Arm
Braccio di reazione



PX52AA.. Single output shaft
Albero semplice in uscita

