

MODELO	X62A	
Ø EJE DE SALIDA	35	mm
RELACIÓN APROXIMADA	24	
RELACIÓN EXACTA	23.60	
VELOCIDAD DE SALIDA	61	RPM
VELOCIDAD DE SALIDA EXACTA	62	RPM
POTENCIA DE ENTRADA	3.00	KW
ROTACIÓN DE ENTRADA	1400	RPM
PAM DE ENTRADA	100B14	
PAR DE SALIDA	463.60	N.m
PAR NOMINAL	410.00	N.m
POTENCIA NOMINAL	2.7	KW
FACTOR DE SERVICIO	0.90	
EFICIENCIA DINÁMICA	0.96	

Cantidad de Aceite (L)

B3/H1	B6/H4	B7/H3	B8/H2	V5/H5	V6/H6
1.25	1.7	0.95	1.6	2.45	1.5

Cargas Radiales y Axiales



n_2 [min-1]	F_A [N]	F_R [N]
250	600	3000
100	780	3900
50	1140	5700
15	1660	8300

PX62AC... Basic Gearbox
Riduttore base

Gearbox weight
peso riduttore **15.80 kg**

M. flanges	Kit code	øF	A
71B5	K023.4.041	160	253
80/90B5	K023.4.042	200	255
100/112B5	K023.4.043	250	264
132B5	KC50.4.043	300	282
80B14	K085.4.046	120	255
90B14	K085.4.045	140	255
100/112B14	K085.4.047	160	264
132B14	KC50.4.041	200	282



PX62A...FB.. Feet
Piedini



PX62A...-F2.. Output flange
Flangia uscita



PX62A...-F3.. Output flange
Flangia uscita



PX62A...-F4.. Output flange
Flangia uscita

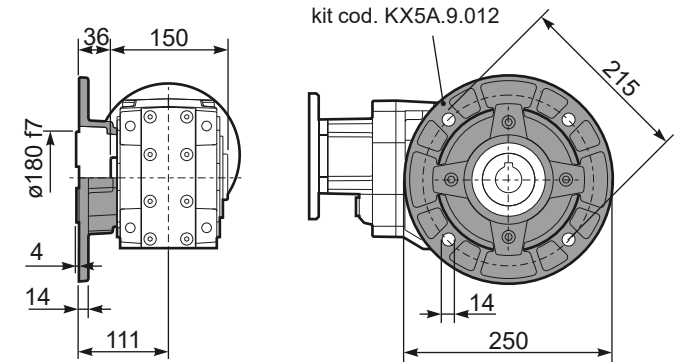

RX62A... Input shaft
Albero in entrata



PX62A...BR.. Reaction Arm
Braccio di reazione



PX62AA.. Single output shaft
Albero semplice in uscita

