

MODELO	X63A	
Ø EJE DE SALIDA	35	mm
RELACIÓN APROXIMADA	77	
RELACIÓN EXACTA	77.23	
VELOCIDAD DE SALIDA	19	RPM
VELOCIDAD DE SALIDA EXACTA	19	RPM
POTENCIA DE ENTRADA	0.55	KW
ROTACIÓN DE ENTRADA	1400	RPM
PAM DE ENTRADA	80B14	
PAR DE SALIDA	272.35	N.m
PAR NOMINAL	410.00	N.m
POTENCIA NOMINAL	0.83	KW
FACTOR DE SERVICIO	1.51	
EFICIENCIA DINÁMICA	0.94	

Cantidad de Aceite (L)

B3/H1	B6/H4	B7/H3	B8/H2	V5/H5	V6/H6
1.8	1.8	1.05	1.7	2.6	1.65

Cargas Radiales y Axiales



$n_2$ [min-1]	$F_A$ [N]	$F_R$ [N]
250	600	3000
100	780	3900
50	1140	5700
15	1660	8300

**PX63AC...** Basic Gearbox  
Riduttore base

Gearbox weight **15.98 kg**  
peso riduttore

M. flanges	Kit code	øF	A
<b>63B5</b>	K063.4.041	140	265
<b>71B5</b>	K063.4.042	160	263
<b>80/90B5</b>	K063.4.043	200	265
<b>71B14</b>	K063.4.047	105	263
<b>80B14</b>	K063.4.046	120	265
<b>90B14</b>	K063.4.041	140	265



**PX63A...FB..** Feet  
Piedini



**PX63A...-F2..** Output flange  
Flangia uscita



**PX63A...-F3..** Output flange  
Flangia uscita



**PX63A...-F4..** Output flange  
Flangia uscita



**RX63A...** Input shaft  
Albero in entrata



**PX63A...BR..** Reaction Arm  
Braccio di reazione

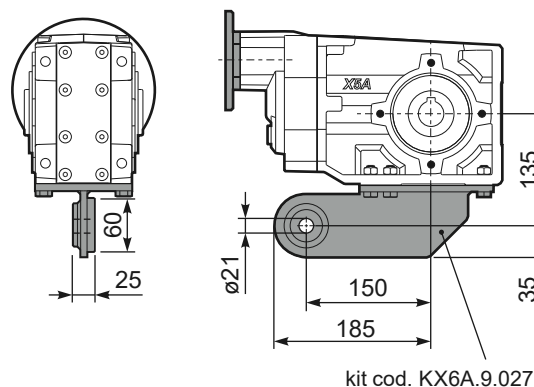

**PX63AA..** Single output shaft  
Albero semplice in uscita

