

MODELO	X63A	
Ø EJE DE SALIDA	35	mm
RELACIÓN APROXIMADA	126	
RELACIÓN EXACTA	125.82	
VELOCIDAD DE SALIDA	12	RPM
VELOCIDAD DE SALIDA EXACTA	12	RPM
POTENCIA DE ENTRADA	0.55	KW
ROTACIÓN DE ENTRADA	1400	RPM
PAM DE ENTRADA	80B5	
PAR DE SALIDA	443.69	N.m
PAR NOMINAL	410.00	N.m
POTENCIA NOMINAL	0.51	KW
FACTOR DE SERVICIO	0.93	
EFICIENCIA DINÁMICA	0.94	

Cantidad de Aceite (L)

B3/H1	B6/H4	B7/H3	B8/H2	V5/H5	V6/H6
1.8	1.8	1.05	1.7	2.6	1.65

Cargas Radiales y Axiales



n_2 [min-1]	F_A [N]	F_R [N]
250	600	3000
100	780	3900
50	1140	5700
15	1660	8300

PX63AC... Basic Gearbox
Riduttore base

Gearbox weight **15.98 kg**
peso riduttore

M. flanges	Kit code	øF	A
63B5	K063.4.041	140	265
71B5	K063.4.042	160	263
80/90B5	K063.4.043	200	265
71B14	K063.4.047	105	263
80B14	K063.4.046	120	265
90B14	K063.4.041	140	265



PX63A...FB.. Feet
Piedini



PX63A...-F2.. Output flange
Flangia uscita



PX63A...-F3.. Output flange
Flangia uscita



PX63A...-F4.. Output flange
Flangia uscita



RX63A... Input shaft
Albero in entrata



PX63A...BR.. Reaction Arm
Braccio di reazione

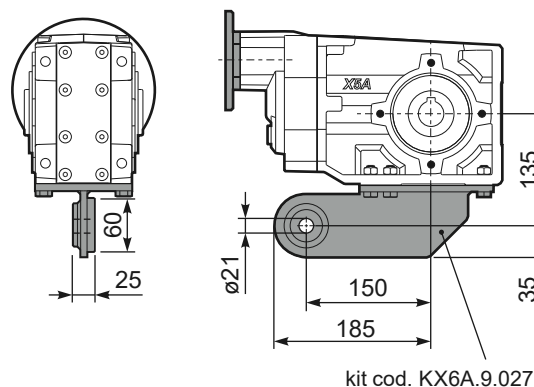

PX63AA.. Single output shaft
Albero semplice in uscita

