

MODELO	FA42	
Ø EJE DE SALIDA	30	mm
RELACIÓN APROXIMADA	10	
RELACIÓN EXACTA	10.04	
VELOCIDAD DE SALIDA	146	RPM
VELOCIDAD DE SALIDA EXACTA	145	RPM
POTENCIA DE ENTRADA	1.10	KW
ROTACIÓN DE ENTRADA	1400	RPM
PAM DE ENTRADA	90B5	
PAR DE SALIDA	72.32	N.m
PAR NOMINAL	240.00	N.m
POTENCIA NOMINAL	3.7	KW
FACTOR DE SERVICIO	3.36	
EFICIENCIA DINÁMICA	0.96	



#### Cantidad de Aceite (L)

B3/H1	B6/H4	B7/H3	B8/H2	V5/H5	V6/H6
1.15	0.7	0.7	0.7	1.2	0.8

#### Cargas Radiales y Axiales



$n_2$ [min-1]	FA [N]	FR [N]
300	300	1500
200	350	1750
120	410	2050
15	800	4000

## PFA42C...

Basic gearbox  
Riduttore base

Gearbox weight  
peso riduttore **9.0 kg**

M. flanges	Kit code	øF	A
63B5	K063.4.041	140	169.5
71B5	K063.4.042	160	167.5
80/90B5	K063.4.043	200	169.5
100/112B5	KC40.4.043	250	184.5
71B14	K063.4.047	105	167.5
80B14	K063.4.046	120	169.5
90B14	K063.4.041	140	169.5
100/112B14	KC40.4.041	160	184.5

● Available torque arms,  
see our web site  
Bracci di reazione disponibili,  
consulta il nostro sito web



**Standard**  
Hollow shaft

**On request**  
A richiesta

## PFA42...-F...

Output flange  
Flangia uscita

Motor Flange	k1
63B5	205.5
71B5	203.5
80/90B5	205.5
100/112B5	220.5
71B14	203.5
80B14	205.5
90B14	205.5
100/112B14	220.5

Available output flanges  
Flange di uscita

a1 ø	b1	c1	e1	f1	s1	Kit code
160	110	10	130	3	9	KX5A.9.010
200	130	13	165	3.5	11	KX5A.9.011
250	180	14	215	4	14	KX5A.9.012

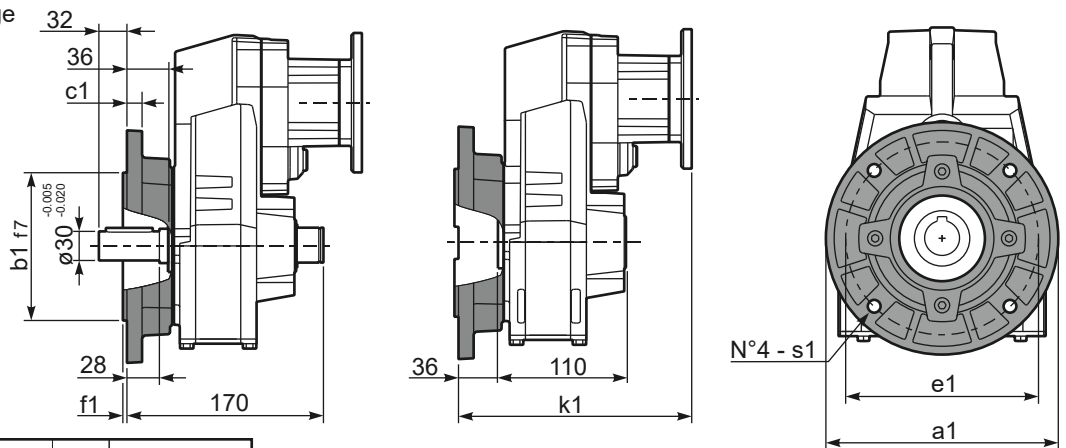

## RFA42C...

Input Shaft  
Albero in entrata



## PFA42 A...

Single output shaft  
Albero uscita semplice



## PFA42D...

Shrink disk  
Calettatore

Kit. Cod KF40.0.210LM

