

MODELO	FA43	
Ø EJE DE SALIDA	30	mm
RELACIÓN APROXIMADA	183	
RELACIÓN EXACTA	183.48	
VELOCIDAD DE SALIDA	8	RPM
VELOCIDAD DE SALIDA EXACTA	8	RPM
POTENCIA DE ENTRADA	0.18	KW
ROTACIÓN DE ENTRADA	1400	RPM
PAM DE ENTRADA	63B5	
PAR DE SALIDA	211.75	N.m
PAR NOMINAL	320.00	N.m
POTENCIA NOMINAL	0.27	KW
FACTOR DE SERVICIO	1.50	
EFICIENCIA DINÁMICA	0.94	



Cantidad de Aceite (L)

B3/H1	B6/H4	B7/H3	B8/H2	V5/H5	V6/H6
1.119	0.7	0.7	0.7	1.35	0.9

Cargas Radiales y Axiales



n_2 [min-1]	FA [N]	FR [N]
300	300	1500
200	350	1750
120	410	2050
15	800	4000

PFA43C...

Basic gearbox
Riduttore base

Gearbox weight
peso riduttore **8.9 kg**

M. flanges	Kit code	øF	A
63B5	K050.4.041	138	175
71B5	K050.4.042	160	172.5
56B14	KC40.4.049	80	172.5
63B14	K050.4.047	90	175
71B14	K050.4.045	105	172.5

● Available torque arms,
see our web site
Bracci di reazione disponibili,
consulta il nostro sito web



Standard
Hollow shaft

On request
A richiesta



PFA43...-F...

Output flange
Flangia uscita

Motor Flange	k1
63B5	211
71B5	208.5
56B14	208.5
63B14	211
71B14	208.5

Available output flanges
Flange di uscita

a1 ø	b1	c1	e1	f1	s1	Kit code
160	110	10	130	3	9	KX5A.9.010
200	130	13	165	3.5	11	KX5A.9.011
250	180	14	215	4	14	KX5A.9.012

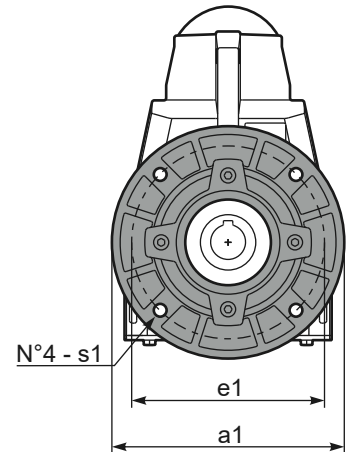
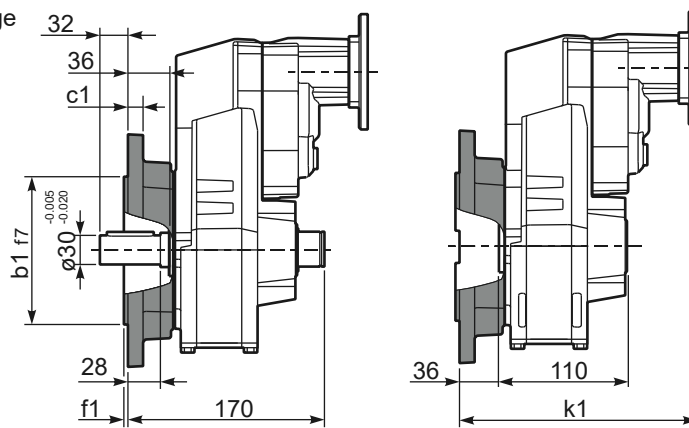

RFA43C...

Input Shaft
Albero in entrata



PFA43 A...

Single output shaft
Albero uscita semplice

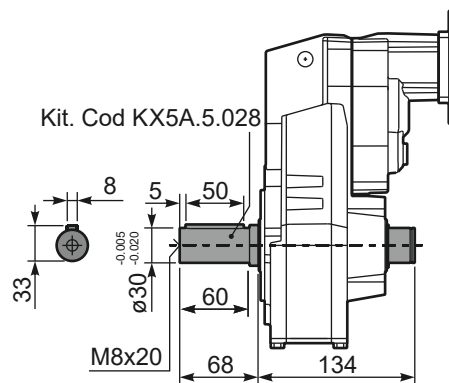

PFA43D...

Shrink disk
Calettatore

