

MODELO	FA53	
Ø EJE DE SALIDA	35	mm
RELACIÓN APROXIMADA	96	
RELACIÓN EXACTA	96.29	
VELOCIDAD DE SALIDA	15	RPM
VELOCIDAD DE SALIDA EXACTA	15	RPM
POTENCIA DE ENTRADA	0.37	KW
ROTACIÓN DE ENTRADA	1400	RPM
PAM DE ENTRADA	71B5	
PAR DE SALIDA	228.43	N.m
PAR NOMINAL	510.00	N.m
POTENCIA NOMINAL	0.83	KW
FACTOR DE SERVICIO	2.24	
EFICIENCIA DINÁMICA	0.94	



#### Cantidad de Aceite (L)

B3/H1	B6/H4	B7/H3	B8/H2	V5/H5	V6/H6
2.15	1.25	1.25	1.45	2.35	1.45

#### Cargas Radiales y Axiales



$n_2$ [min-1]	FA [N]	FR [N]
300	400	2000
200	440	2200
120	500	2500
15	1140	5700

**PFA53C...**

Basic gearbox  
Riduttore base

Gearbox weight  
peso riduttore **15.5 kg**

M. flanges	Kit code	øF	A
63B5	K063.4.041	140	239
71B5	K063.4.042	160	237
80/90B5	K063.4.043	200	239
71B14	K063.4.047	105	237
80B14	K063.4.046	120	239
90B14	K063.4.041	140	239

● Available torque arms,  
see our web site  
Bracci di reazione disponibili,  
consulta il nostro sito web



**Standard**  
Hollow shaft



**On request**  
A richiesta



**PFA53...-F...**

Output flange  
Flangia uscita

Motor Flange	k1
63B5	272
71B5	270
80/90B5	272
71B14	270
80B14	272
90B14	272



Available output flanges  
Flange di uscita

a1 ø	b1	c1	e1	s1	Kit code
250	180	13	215	14	KF60.9.011
-	-	-	-	-	-

**RFA53C...**

Input Shaft  
Albero in entrata

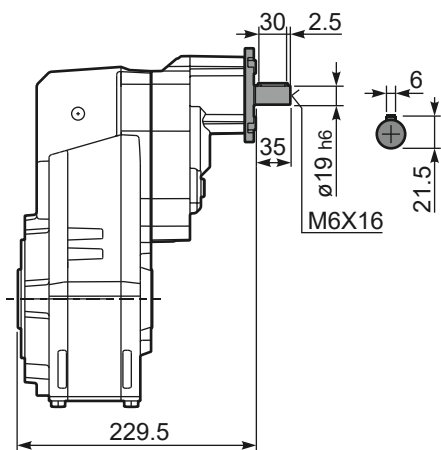

**PFA53 A...**

Single output shaft  
Albero uscita semplice



**PFA53D...**

Shrink disk  
Calettatore

