

Ficha Técnica  
 Reductor de velocidad  
 SIN-FIN CORONA REDONDO



MODELO	030	
Ø EJE DE SALIDA	14	mm
RELACIÓN APROXIMADA	30	
RELACIÓN EXACTA	30.00	
VELOCIDAD DE SALIDA	49	RPM
VELOCIDAD DE SALIDA EXACTA	49	RPM
POTENCIA DE ENTRADA	0.09	KW
ROTACIÓN DE ENTRADA	1400	RPM
PAM DE ENTRADA	56B5	
PAR DE SALIDA	11.42	N.m
PAR NOMINAL	21.00	N.m
POTENCIA NOMINAL	0.17	KW
FACTOR DE SERVICIO	1.89	
EFICIENCIA DINÁMICA	0.62	



Cantidad de Aceite (L)

B3/H1	B6/H4	B7/H3	B8/H2	V5/H5	V6/H6
0.03	0.03	0.03	0.03	0.03	0.03

Cargas Radiales y Axiales



$n_2$ [min-1]	FA [N]	FR [N]
200	120	600
100	160	800
50	200	1000
15	280	1400

Universal Motors S.A.  
 Rua Comendador Brandão, 484  
 4495-375 Póvoa de Varzim  
[geral@universalmotors.pt](mailto:geral@universalmotors.pt)  
 TEL.: 252 299 080

Universal Motors UK, Ltd  
 Unit E2, Meltham Mills Road  
 West Yorkshire HD9 4AR  
[enquiries@universalmotors-group.co.uk](mailto:enquiries@universalmotors-group.co.uk)  
 TEL.: +44(0) 1484660222

Universal Motors SL  
 C/La Habana n.6 nave 4 PI Camporroso  
 28806 Alcala de Henares  
[info@universalmotors-group.es](mailto:info@universalmotors-group.es)  
 TEL.: 918 864 213

**P030FB...** Basic wormbox  
Riduttore base

Gearbox weight  
peso riduttore **1.05 kg**

M. flanges	Kit code	øF	A
<b>56B5</b>	K030.4.041	120	61.5
<b>63B5</b>	K030.4.042	140	62.5
<b>56B14</b>	K030.4.046	80	61.5
<b>63B14</b>	K030.4.045	90	62.5



**P030PA...** Feet  
Piedini

**P030PB...** Feet  
Piedini

**P030PV...** Feet  
Piedini



	H	R	S	T	U	V	Y	W	øZ	kit code
type B	55	66	3	87	50	78	94	107	ø6.5	K030.9.022
type S	52	66	3	87	52	90	91	104	ø6.5	KS030.9.023

**P030FC...** Output flange  
Flangia uscita

**P030BR...** Reaction arm  
Braccio di reazione



type B	øD	E	G	L	N	O	P	Q	kit code
<b>FC</b>	50 <sup>+0.15</sup> / <sub>+0.05</sub>	6	6	50.5	23	68	80	7	① K030.9.010 ② -
<b>FL</b>	60 <sup>+0.15</sup> / <sub>+0.05</sub>	6	6	55.5	28	87	110	8.5	① K045.9.010 ② -

type S	øD	E	G	L	N	O	P	Q	kit code
<b>F1</b>	40 <sup>+0.15</sup> / <sub>+0.10</sub>	3.5	5.5	49	21.5	56	80	6.5	① KS030.9.012 ② -

**P030.....S...** Single Shaft  
Albero lento semplice

**P030.....D...** Double Shaft  
Albero lento bisp.

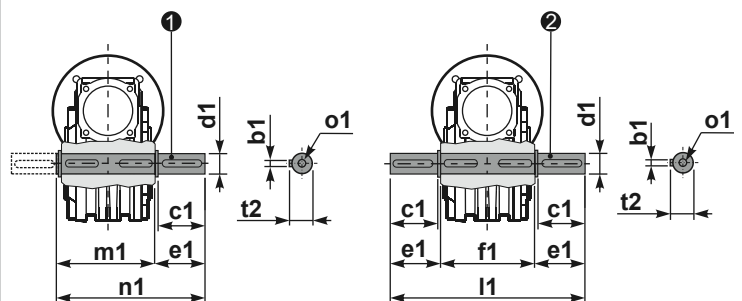

① kit cod. K030.5.028 type B    ② kit cod. K030.5.029 type B

**R030FB...** Input shaft  
Albero in entrata

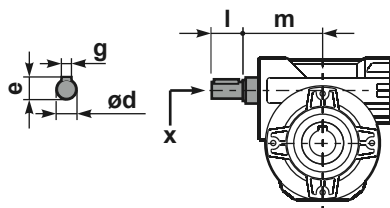

	ød	e	g	l	m	x	kit code
type B	9 h6	10.2	3	20	58	-	K030.5.006 PAM63
type S	-	-	-	-	-	-	-

	b1	c1	d1	e1	f1	l1	m1	n1	t2	o1
type B	5	25	14 <sup>-0.005</sup> / <sub>-0.020</sub>	35.5	55	126	59	94.5	16	M5x14
type S	-	-	-	-	-	-	-	-	-	-