

Ficha Técnica  
 Reductor de velocidad  
 SIN-FIN CORONA REDONDO



MODELO	045	
Ø EJE DE SALIDA	18	mm
RELACIÓN APROXIMADA	7	
RELACIÓN EXACTA	7.00	
VELOCIDAD DE SALIDA	209	RPM
VELOCIDAD DE SALIDA EXACTA	209	RPM
POTENCIA DE ENTRADA	0.37	KW
ROTACIÓN DE ENTRADA	1400	RPM
PAM DE ENTRADA	71B5	
PAR DE SALIDA	14.13	N.m
PAR NOMINAL	30.00	N.m
POTENCIA NOMINAL	0.8	KW
FACTOR DE SERVICIO	2.16	
EFICIENCIA DINÁMICA	0.80	



Cantidad de Aceite (L)

B3/H1	B6/H4	B7/H3	B8/H2	V5/H5	V6/H6
0.09	0.09	0.09	0.09	0.09	0.09

Cargas Radiales y Axiales



$n_2$ [min-1]	FA [N]	FR [N]
200	180	900
100	220	1100
50	260	1400
15	400	2000

Universal Motors S.A.  
 Rua Comendador Brandão, 484  
 4495-375 Póvoa de Varzim  
[geral@universalmotors.pt](mailto:geral@universalmotors.pt)  
 TEL.: 252 299 080

Universal Motors UK, Ltd  
 Unit E2, Meltham Mills Road  
 West Yorkshire HD9 4AR  
[enquiries@universalmotors-group.co.uk](mailto:enquiries@universalmotors-group.co.uk)  
 TEL.: +44(0) 1484660222

Universal Motors SL  
 C/La Habana n.6 nave 4 PI Camporroso  
 28806 Alcala de Henares  
[info@universalmotors-group.es](mailto:info@universalmotors-group.es)  
 TEL.: 918 864 213

**P045FB...** Basic wormbox  
Riduttore base

Gearbox weight  
peso riduttore **2.40 kg**

M. flanges	Kit code	øF	A
<b>63B5</b>	K050.4.041	138	74
<b>71B5</b>	K050.4.042	160	71.5
<b>56B14</b>	KC40.4.049	80	71.5
<b>63B14</b>	K050.4.047	90	74
<b>71B14</b>	K050.4.045	105	71.5



**P045PA...** Feet  
Piedini

**P045PB...** Feet  
Piedini

**P045PV...** Feet  
Piedini



	H	R	S	T	U	V	Y	W	øZ	kit code
type B	72	81	3	100	52	98	121	144	ø10.5	K045.9.022
type S	71	84	8	100	70	90	120	143	ø8	KS045.9.023

**P045FC...** Output flange  
Flangia uscita

**P045BR...** Reaction arm  
Braccio di reazione



type B	øD	E	G	L	N	O	P	Q	kit code
<b>FC</b>	60 <sup>+0.15</sup> / <sub>+0.05</sub>	9	9	60.5	28	87	110	8.5	① K045.9.010 ② -
<b>FL</b>	60 <sup>+0.15</sup> / <sub>+0.05</sub>	9	9	90.5	58	87	110	8.5	① K045.9.010 ② K045.0.200

type S	øD	E	G	L	N	O	P	Q	kit code
<b>F1</b>	95 <sup>+0.20</sup> / <sub>+0.15</sub>	4	11	73.5	41	115	140	9	① KS045.9.013 ② -
<b>F2</b>	60 <sup>+0.15</sup> / <sub>+0.05</sub>	9	9	60.5	19	87	110	8.5	① KS045.9.010 ② S045.0.204
<b>F3</b>	80 <sup>+0.15</sup> / <sub>+0.10</sub>	3	8	51.5	19	100	120	9	① KS045.9.014 ② -

**P045.....S...** Single Shaft  
Albero lento semplice

**P045.....D...** Double Shaft  
Albero lento bisp.

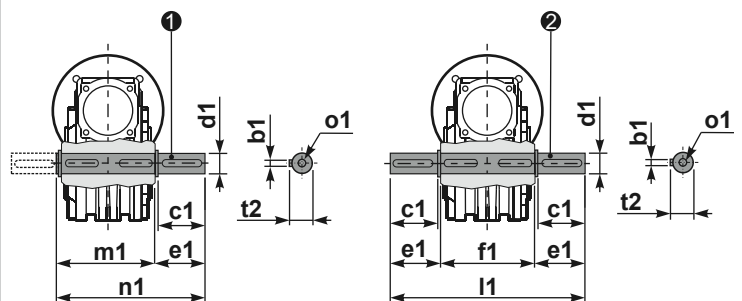

① kit cod. K045.5.028 type B  
kit cod. KS045.5.030 type S

② kit cod. K045.5.029 type B

**R045FB...** Input shaft  
Albero in entrata



	ød	e	g	l	m	x	kit code
type B	11 h6	12.5	4	30	68	-	① K045.5.006 PAM71 ② -
type S	-	-	-	-	-	-	① - ② -

	b1	c1	d1	e1	f1	l1	m1	n1	t2	o1
type B	6	32	18 <sup>-0.005</sup> / <sub>-0.020</sub>	43	65	151	70	113	20.5	M6x18
type S	6	40	19 <sup>-0.005</sup> / <sub>-0.020</sub>	58.8	-	-	70	128.5	21.5	M8x20