

MODELO	050	
Ø EJE DE SALIDA	25	mm
RELACIÓN APROXIMADA	45	
RELACIÓN EXACTA	43.00	
VELOCIDAD DE SALIDA	32	RPM
VELOCIDAD DE SALIDA EXACTA	34	RPM
POTENCIA DE ENTRADA	0.25	KW
ROTACIÓN DE ENTRADA	1400	RPM
PAM DE ENTRADA	71B5	
PAR DE SALIDA	48.39	N.m
PAR NOMINAL	68.00	N.m
POTENCIA NOMINAL	0.35	KW
FACTOR DE SERVICIO	1.40	
EFICIENCIA DINÁMICA	0.66	



#### Cantidad de Aceite (L)

B3/H1	B6/H4	B7/H3	B8/H2	V5/H5	V6/H6
0.14	0.14	0.14	0.14	0.14	0.14

#### Cargas Radiales y Axiales

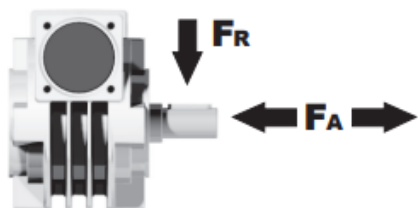

$n_2$ [min-1]	FA [N]	FR [N]
200	240	1200
100	300	1500
50	380	1900
15	560	2800

**P050FB...** Basic wormbox  
Riduttore base

Gearbox weight  
peso riduttore **3.00 kg**

M. flanges	Kit code	øF	A
<b>63B5</b>	K050.4.041	138	78.5
<b>71B5</b>	K050.4.042	160	76
<b>80B5</b>	K050.4.043	200	76.5
<b>56B14</b>	KC40.4.049	80	76
<b>63B14</b>	K050.4.047	90	78.5
<b>71B14</b>	K050.4.045	105	76
<b>80B14</b>	K050.4.046	120	76.5



4 holes M6x9

Mounting holes position  
Posizione fori di montaggio

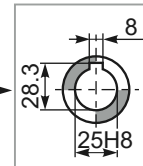

Standard  
Hollow shaft

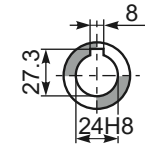

On request "type S"  
A richiesta "tipo S"

**P050PA...** Feet  
Piedini

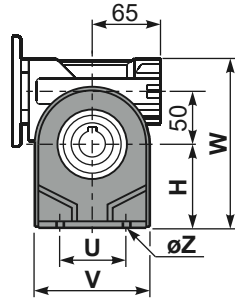
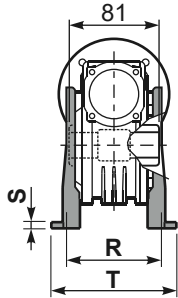

**P050PB...** Feet  
Piedini

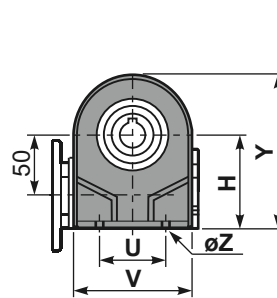

**P050PV...** Feet  
Piedini

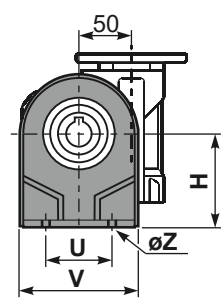

	H	R	S	T	U	V	Y	W	øZ	kit code
type B	82	98.5	3.5	123	63	113	138.5	163	ø10.5	K050.9.022
type S	85	96	10	114	85	110	139.5	166	ø10	KS050.9.023

**P050FC...** Output flange  
Flangia uscita

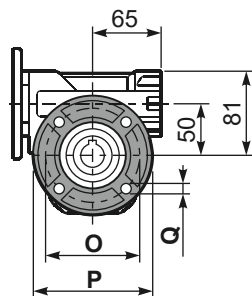
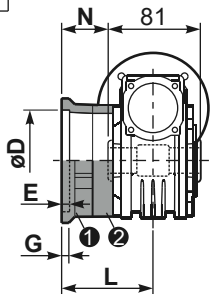

type B	øD	E	G	L	N	O	P	Q	kit code
<b>FC</b>	70 <sup>+0.20</sup> / <sub>+0.15</sub>	9	12	85	44.5	90	123	10.5	1 K050.9.010 2 -
<b>FL</b>	70 <sup>+0.20</sup> / <sub>+0.15</sub>	9	12	114.5	74	90	123	10.5	1 K050.9.010 2 K050.0.200
type S	øD	E	G	L	N	O	P	Q	kit code
<b>F1</b>	110 <sup>+0.20</sup> / <sub>+0.15</sub>	4	11	83.5	43	130	160	10	1 KS050.9.012 2 -
<b>F2</b>	70 <sup>+0.20</sup> / <sub>+0.15</sub>	9	12	76.5	36	90	123	10.5	1 KS050.9.014 2 -
<b>F3</b>	95 <sup>+0.035</sup> / <sub>0</sub>	4	10	66.5	26	115	140	10	1 KS050.9.013 2 -

**P050BR...** Reaction arm  
Braccio di reazione

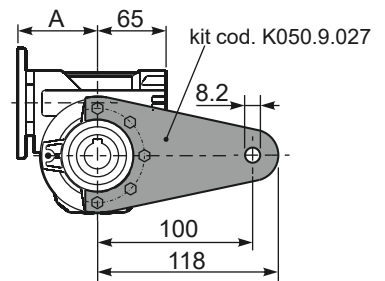
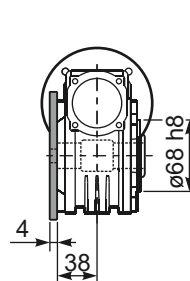

**P050.....S...** Single Shaft  
Albero lento semplice

**P050.....D...** Double Shaft  
Albero lento bisp.

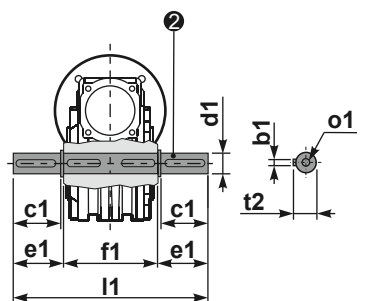
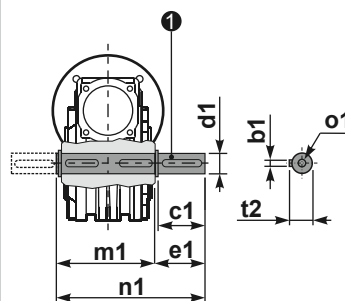

1 kit cod. K050.5.028 type B  
kit cod. KS050.5.030 type S

2 kit cod. K050.5.029 type B

**R050FB...** Input shaft  
Albero in entrata

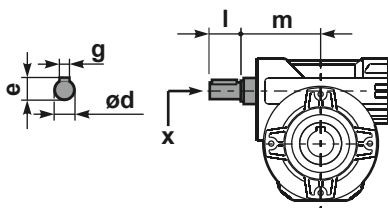

	ød	e	g	l	m	x	kit code
type B	16 h6	18	5	30	74.5	M6x16	1 K050.5.006 PAM71 2 K050.5.007 PAM80
type S	14 h6	16	5	30	74.5	M5x10	1 KS050.5.008 PAM71 2 KS050.5.009 PAM80

	b1	c1	d1	e1	f1	l1	m1	n1	t2	o1
type B	8	52	25 <sup>-0.005</sup> / <sub>-0.020</sub>	59.5	81	200	86.5	146	28	M8x20
type S	8	50	24 <sup>-0.005</sup> / <sub>-0.020</sub>	68.8	-	-	86.5	155	27	M8x20