

MODELO	411A	
Ø EJE DE SALIDA	19	mm
RELACIÓN APROXIMADA	8	
RELACIÓN EXACTA	8.22	
VELOCIDAD DE SALIDA	183	RPM
VELOCIDAD DE SALIDA EXACTA	178	RPM
POTENCIA DE ENTRADA	0.75	KW
ROTACIÓN DE ENTRADA	1400	RPM
PAM DE ENTRADA	80B5	
PAR DE SALIDA	38.69	N.m
PAR NOMINAL	38.00	N.m
POTENCIA NOMINAL	0.6899999999999999	KW
FACTOR DE SERVICIO	0.92	
EFICIENCIA DINÁMICA	0.92	

Cantidad de Aceite (L)

B3/H1	B6/H4	B7/H3	B8/H2	V5/H5	V6/H6
0.1	0.1	0.1	0.1	0.1	0.1

Cargas Radiales y Axiales

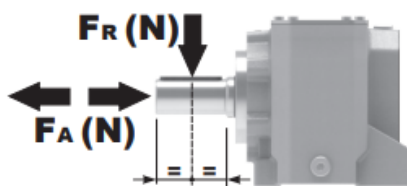

n_2 [min-1]	FA [N]	FR [N]
700	182	910
400	230	1150
200	290	1450
140	320	1600

P411-F... Output flange
flange di uscita

Gearbox weight
peso riduttore **3.20 kg**



***Available output shaft / Albero di uscita**

	Shaft - d1	p1	h1	x
Standard	∅ 19x40	6	21.5	M6x16
On request A richiesta	∅ 14x30 ∅ 24x40	5 8	16 27	M5x13 M6x16

Available output flanges / flange di uscita

a1 ∅	b1	c1	e1	f1	s1	kit code
120	80	11.5	100	3	9*	KC30.9.010
140	95	11.5	115	3	9	KC30.9.011
160	110	11.5	130	3.5	9	KC30.9.012
200	130	11.5	165	3.5	11	KC30.9.013

*Holes position
posizione fori

P411-H1... With feet
Con piedini

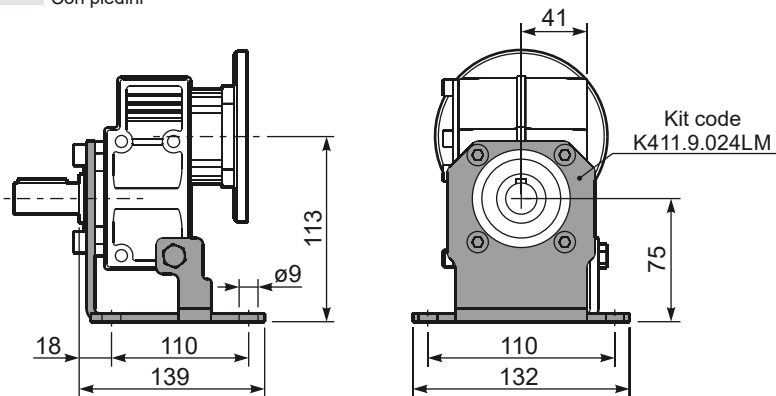

R411-N... Input Shaft
Albero in entrata

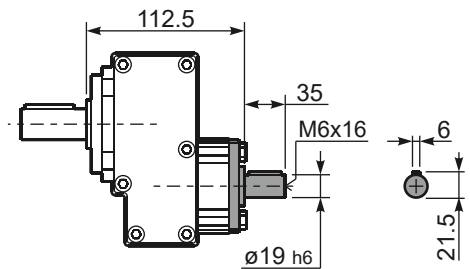

P411-N... Basic gearbox
Riduttore base



*See the table of output shaft for the complete list of diameters

B5 Motor Flanges	A	g6	k1	kit code
63 B5	121.5	140	125	K063.4.041
71 B5	119.5	160	123	K063.4.042
80/90 B5	121.5	200	125	K063.4.043

B14 Motor Flanges	A	g6	k1	kit code
71 B14	119.5	105	123	K063.4.047
80 B14	121.5	120	125	K063.4.046
90 B14	121.5	140	125	K063.4.041