

MODELO	202A	
Ø EJE DE SALIDA	16	mm
RELACIÓN APROXIMADA	10	
RELACIÓN EXACTA	9.85	
VELOCIDAD DE SALIDA	146	RPM
VELOCIDAD DE SALIDA EXACTA	148	RPM
POTENCIA DE ENTRADA	0.09	KW
ROTACIÓN DE ENTRADA	1400	RPM
PAM DE ENTRADA	56B14	
PAR DE SALIDA	5.80	N.m
PAR NOMINAL	60.00	N.m
POTENCIA NOMINAL	0.93	KW
FACTOR DE SERVICIO	10.33	
EFICIENCIA DINÁMICA	0.96	

Cantidad de Aceite (L)

B3/H1	B6/H4	B7/H3	B8/H2	V5/H5	V6/H6
0.15	0.15	0.15	0.15	0.15	0.15

Cargas Radiales y Axiales



n_2 [min-1]	FA [N]	FR [N]
300	140	700
200	185	924
120	270	1350
70	340	1700

Gearbox weight With flange **3.3 kg**
peso riduttore With feet **3.7 Kg**

P202A-B1... With feet
 Con piedini

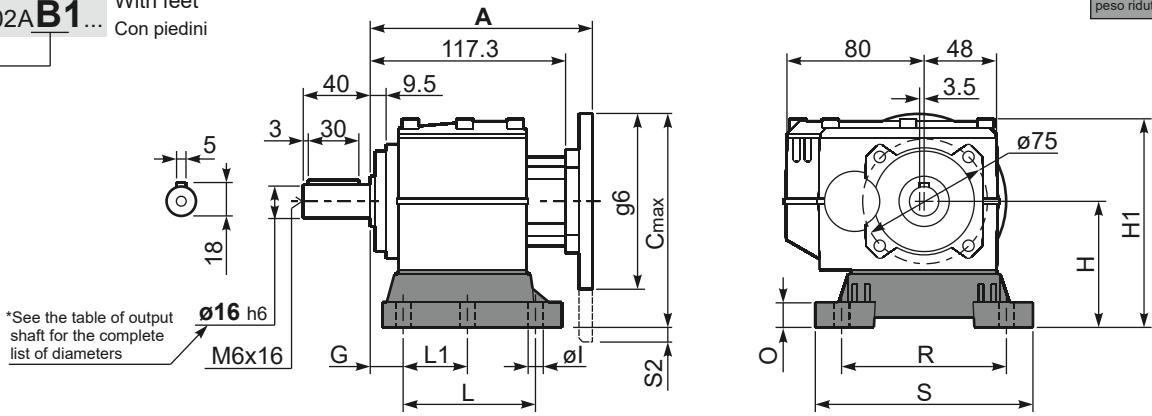

*See the table of output shaft for the complete list of diameters

Feet Code	Market reference	G	H	R	L	L1	S	H1	O	Ø1	S2 only with motor flange	B5 max. Flange	kit code
B1	112	18	85	110	87	50	130	133	15	9	-	-	KC30.9.022
B2	212/3	18	100	130	107.5	60	155	145	5	11	-	-	KC30.9.023LM
S1	17-32	18	75	110	110	50	130	123	15	9	-	63B5	KC30.9.024

Other feet are available, see our web site
 Sono disponibili altri piedini, consulta il nostro sito web

A see on page bottom

Most popular types
 Tipi più diffusi

P202A-F... Output flanges
 flange di uscita

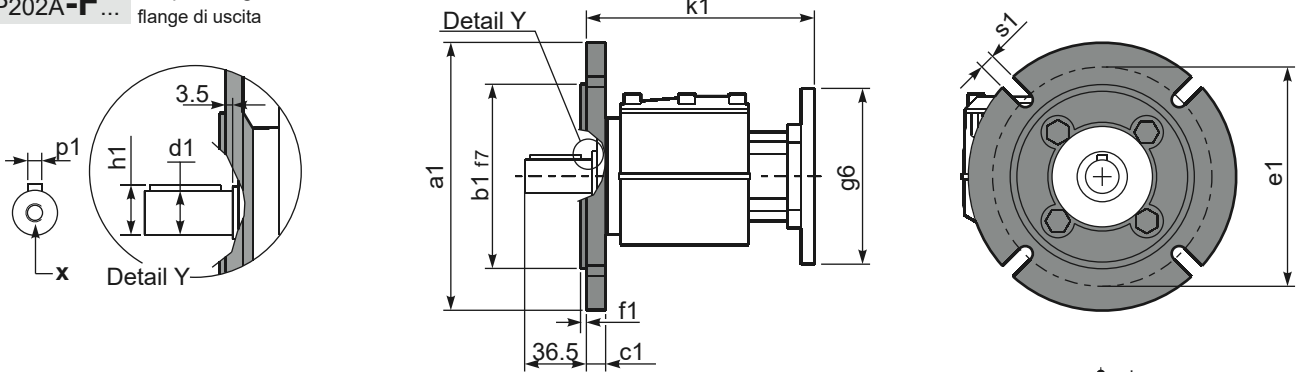

***Available output shaft / Albero di uscita**

	Shaft - d1	p1	h1	x
Standard	Ø 16x40	5	18	M6x16
On request A richiesta	Ø 14x30	5	16	M6x16
	Ø 20x40	6	22.5	M8x19
	Ø 25x50	8	28	M8x19

Available output flanges / flange di uscita

a1 Ø	b1	c1	e1	f1	s1	kit code
120	80	11.5	100	3	9*	KC30.9.010
140	95	11.5	115	3	9	KC30.9.011
160	110	11.5	130	3.5	9	KC30.9.012
200	130	11.5	165	3.5	11	KC30.9.013

* Holes position
 Posizione fori

With flange and feet only on request. Ask for compatibility

P202A-N... Basic gearbox
 Riduttore base

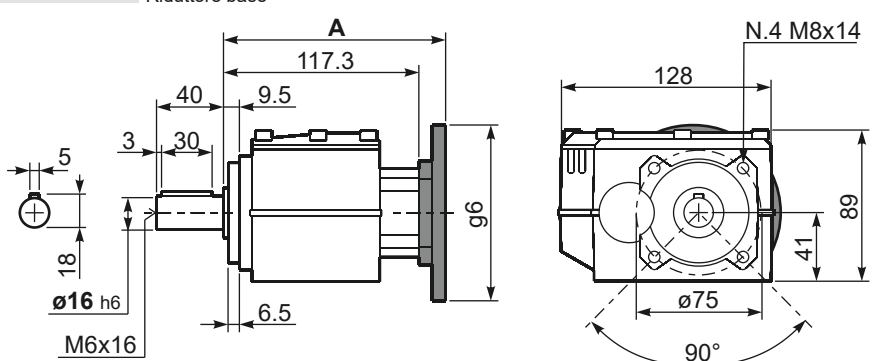

R202A-N... Input Shaft
 Albero in entrata

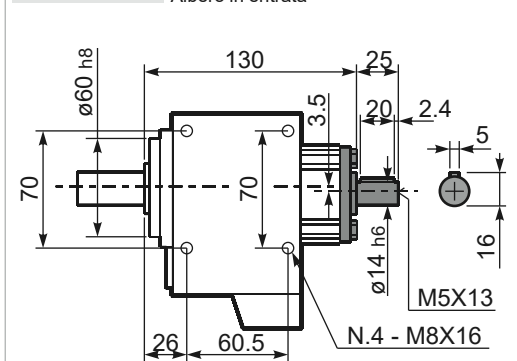

B5 Motor Flanges	A	C _{max}	g6	k1	kit code
63 B5	135.8	170	140	139.3	K050.4.041
71 B5	133.3	180	160	136.8	K050.4.042

B14 Motor Flanges	A	C _{max}	g6	k1	kit code
56 B14	133.3	139	80	136.8	KC40.4.049
63 B14	135.8	146	90	139.3	K050.4.047
71 B14	133.3	152.5	105	136.8	K050.4.045