

MODELO	UMSG40	
Ø EJE DE SALIDA	18	mm
RELACIÓN APROXIMADA	50	
RELACIÓN EXACTA	50.00	
VELOCIDAD DE SALIDA	29	RPM
VELOCIDAD DE SALIDA EXACTA	29	RPM
POTENCIA DE ENTRADA	0.18	KW
ROTACIÓN DE ENTRADA	1400	RPM
PAM DE ENTRADA	63B5	
PAR DE SALIDA	38.06	N.m
PAR NOMINAL	38.06	N.m
POTENCIA NOMINAL	0.18	KW
FACTOR DE SERVICIO	1.00	
EFICIENCIA DINÁMICA	0.62	



Cantidad de Aceite (L)

B3/H1	B6/H4	B7/H3	B8/H2	V5/H5	V6/H6
0.1	0.1	0.1	0.1	0.1	0.1

Cargas Radiales y Axiales



n_2 [min ⁻¹]	FA [N]	FR [N]
200	180	900
100	220	1100
50	260	1400
15	400	2000



Square flange FA

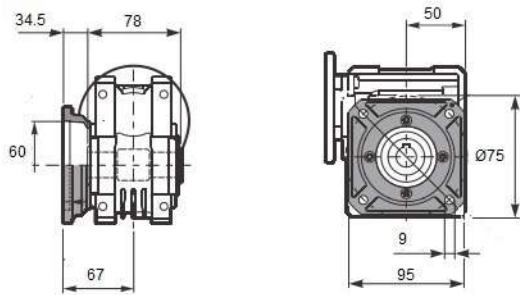

Square flange FB

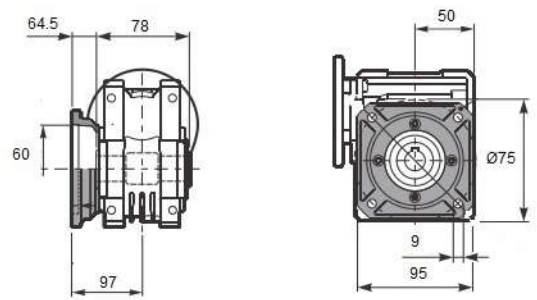

Feet



Reaction arm

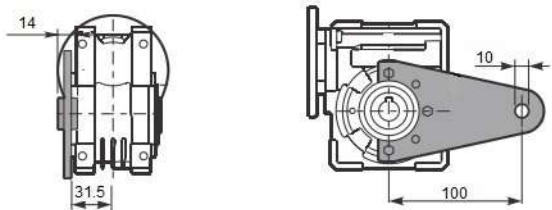

Single Shaft



b1	c1	d1	e1	m1	n1	t2	o1
6	40	18	43	78	128	20.5	M6

1400 rpm	N2 rpm	Relação i	P1 kW	FS	P1n kW	M2 Nm	Rend. %	Fr max N	Veio		Flanges de entrada		
									Entrada	Saída	56	63	71
UMSG40	187	7,5	0,55	1,6	0,9	40	0,87	1315	14	18		B14/B5	B14/B5
	140	10	0,55	1,3	0,69	40	0,85	1447			B14/B5	B14/B5	
	93	15	0,55	0,9	0,48	39	0,82	1657			B14/B5	B14/B5	
	70	20	0,37	1,0	0,37	39	0,78	1824			B14/B5	B14/B5	
	56	25	0,25	1,2	0,3	38	0,75	1964			B14/B5	B14/B5	
	47	30	0,25	1,2	0,31	44	0,7	2087			B14/B5	B14/B5	
	35	40	0,25	0,9	0,23	41	0,65	2298			B14/B5	B14/B5	
	28	50	0,18	1,0	0,18	37	0,62	2475			B14/B5	B14/B5	
	23	60	0,12	1,3	0,15	35	0,58	2630			B14/B5	B14/B5	
	18	80	0,12	1,0	0,12	33	0,52	2895			B14/B5	B14/B5	
	14	100	0,09	1,0	0,09	29	0,47	3118			B14/B5	B14/B5	