

MODELO	UMSG75	
Ø EJE DE SALIDA	28	mm
RELACIÓN APROXIMADA	7.5	
RELACIÓN EXACTA	7.50	
VELOCIDAD DE SALIDA	195	RPM
VELOCIDAD DE SALIDA EXACTA	195	RPM
POTENCIA DE ENTRADA	1.50	KW
ROTACIÓN DE ENTRADA	1400	RPM
PAM DE ENTRADA	90B14	
PAR DE SALIDA	68.29	N.m
PAR NOMINAL	186.67	N.m
POTENCIA NOMINAL	4.1	KW
FACTOR DE SERVICIO	2.73	
EFICIENCIA DINÁMICA	0.89	

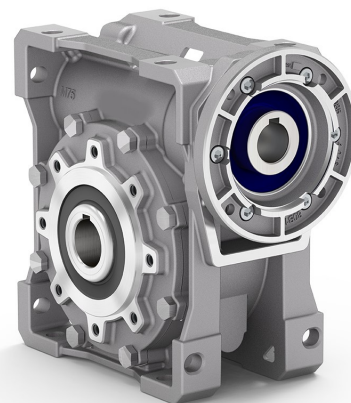

#### Cantidad de Aceite (L)

B3/H1	B6/H4	B7/H3	B8/H2	V5/H5	V6/H6
0.5	0.5	0.5	0.5	0.5	0.5

#### Cargas Radiales y Axiales



$n_2$ [min <sup>-1</sup> ]	FA [N]	FR [N]
200	460	2300
100	560	2800
50	720	3600
15	1000	5000

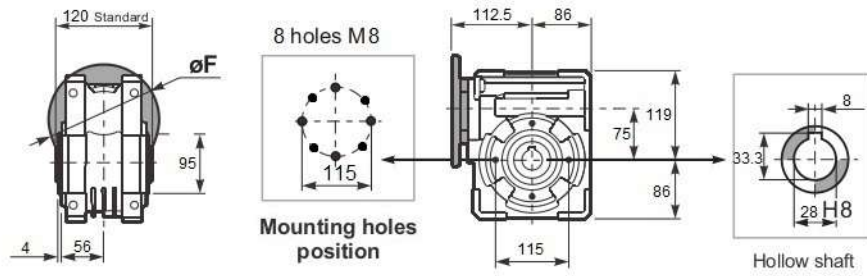

### Square flange FA

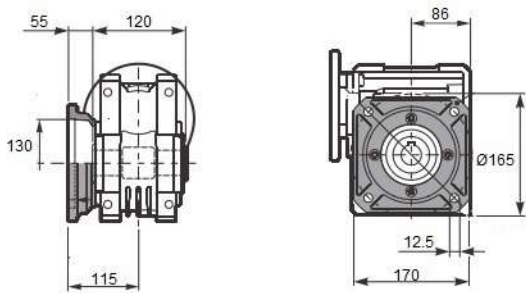

### Round flange FB

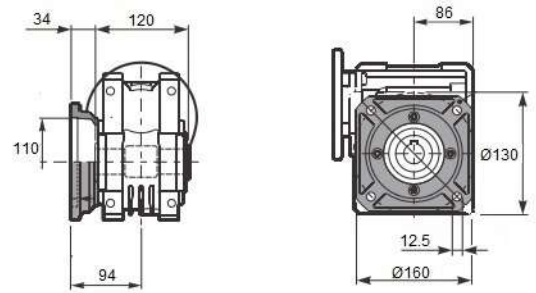

### Feet

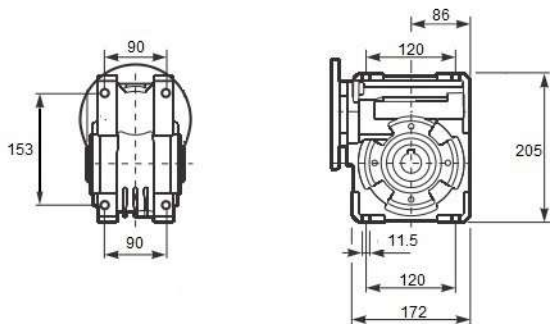

### Reaction arm

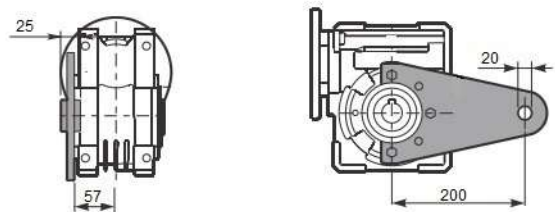

### Single Shaft

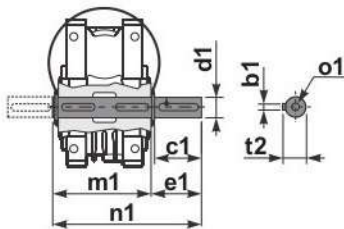

b1	c1	d1	e1	m1	n1	t2	o1
8	60	28	63.5	120	192	31	M10

1400 rpm	N2	Relação	P1	FS	P1n	M2	Rend.	Fr max	Veio		Flanges de entrada				
	rpm	i	kW		kW	Nm	%	N	Entrada	Saída	71	80	90	100/112	
UMSG75	187	7,5	4	1,0	4,1	185	0,89	2785	28	28			B14/B5	B14/B5	
	140	10	3	1,1	3,2	190	0,88	3065					B14/B5	B14/B5	
	93	15	2,2	1,0	2,3	198	0,85	3509					B14/B5	B14/B5	
	70	20	1,5	1,3	1,9	210	0,82	3862	24				B14/B5	B14/B5	
	56	25	1,5	1,0	1,5	202	0,8	4160					B14/B5	B14/B5	
	47	30	1,5	1,0	1,5	233	0,76	4421					B14/B5	B14/B5	
	35	40	1,1	1,0	1,1	216	0,72	4865	19				B14/B5	B14/B5	
	28	50	0,75	1,2	0,89	206	0,69	5241					B5	B14/B5	
	23	60	0,75	1,0	0,75	197	0,65	5569					B5	B14/B5	
	18	80	0,55	1,1	0,58	197	0,6	6130	14				B5	B14/B5	
	14	100	0,37	1,3	0,48	180	0,55	6603					B5	B14/B5	