

MODELO	UMSG90	
Ø EJE DE SALIDA	35	mm
RELACIÓN APROXIMADA	80	
RELACIÓN EXACTA	80.00	
VELOCIDAD DE SALIDA	18	RPM
VELOCIDAD DE SALIDA EXACTA	18	RPM
POTENCIA DE ENTRADA	0.75	KW
ROTACIÓN DE ENTRADA	1400	RPM
PAM DE ENTRADA	80B14	
PAR DE SALIDA	257.83	N.m
PAR NOMINAL	285.33	N.m
POTENCIA NOMINAL	0.83	KW
FACTOR DE SERVICIO	1.11	
EFICIENCIA DINÁMICA	0.63	



#### Cantidad de Aceite (L)

B3/H1	B6/H4	B7/H3	B8/H2	V5/H5	V6/H6
1	1	1	1	1	1

#### Cargas Radiales y Axiales



$n_2$ [min <sup>-1</sup> ]	FA [N]	FR [N]
200	500	2500
100	600	3000
50	800	4000
15	1160	5800



### Square flange FA



### Round flange FB

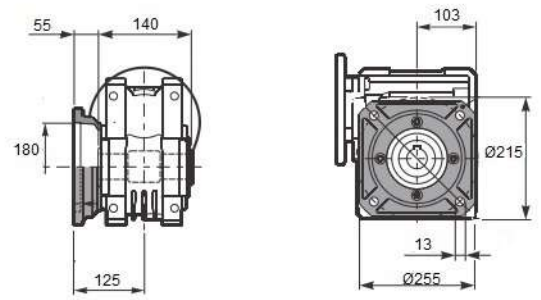

### Feet



### Reaction arm



### Single Shaft



b1	c1	d1	e1	m1	n1	t2	o1
10	80	35	84.5	140	234	38	M12

1400 rpm	N2	Relação	P1	FS	P1n	M2	Rend.	Fr max	Veio		Flanges de entrada		
	rpm	i	kW		kW	Nm	%	N	Entrada	Saída	80	90	100/112
UMSG90	187	7,5	5,5	1,1	6,3	287	0,9	3081	28	35		B14/B5	B14/B5
	140	10	5,5	0,9	5,1	306	0,89	3391			B14/B5	B14/B5	
	93	15	4	1,0	4,1	357	0,86	3882			B14/B5	B14/B5	
	70	20	3	1,0	3,1	351	0,84	4273			B14/B5	B14/B5	
	56	25	2,2	1,1	2,4	332	0,82	4603			B14/B5	B14/B5	
	47	30	2,2	1,2	2,6	415	0,78	4891			B14/B5	B14/B5	
	35	40	1,5	1,2	1,8	363	0,75	5383	24	35	B14/B5	B14/B5	
	28	50	1,1	1,3	1,4	339	0,72	5799			B14/B5	B14/B5	
	23	60	1,1	1,0	1,1	307	0,69	6163			B14/B5	B14/B5	
	18	80	0,75	1,1	0,83	285	0,63	6783			B14/B5		
	14	100	0,55	1,2	0,67	270	0,59	7306	19		B14/B5		