

MODELO	UMSG90	
Ø EJE DE SALIDA	35	mm
RELACIÓN APROXIMADA	40	
RELACIÓN EXACTA	40.00	
VELOCIDAD DE SALIDA	37	RPM
VELOCIDAD DE SALIDA EXACTA	37	RPM
POTENCIA DE ENTRADA	2.20	KW
ROTACIÓN DE ENTRADA	1400	RPM
PAM DE ENTRADA	90B5	
PAR DE SALIDA	450.18	N.m
PAR NOMINAL	368.33	N.m
POTENCIA NOMINAL	1.8	KW
FACTOR DE SERVICIO	0.82	
EFICIENCIA DINÁMICA	0.75	



Cantidad de Aceite (L)

B3/H1	B6/H4	B7/H3	B8/H2	V5/H5	V6/H6
1	1	1	1	1	1

Cargas Radiales y Axiales



n_2 [min ⁻¹]	FA [N]	FR [N]
200	500	2500
100	600	3000
50	800	4000
15	1160	5800



Square flange FA



Round flange FB

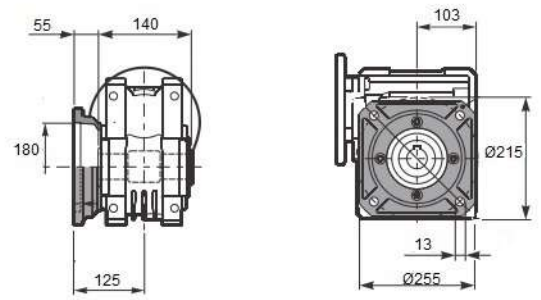

Feet



Reaction arm



Single Shaft



b1	c1	d1	e1	m1	n1	t2	o1
10	80	35	84.5	140	234	38	M12

1400 rpm	N2 rpm	Relação i	P1 kW	FS	P1n kW	M2 Nm	Rend. %	Fr max N	Veio		Flanges de entrada			
									Entrada	Saída	80	90	100/112	
	UMSG90	187	7,5	5,5	1,1	6,3	287	0,9	3081	28	35		B14/B5	B14/B5
140		10	5,5	0,9	5,1	306	0,89	3391				B14/B5	B14/B5	
93		15	4	1,0	4,1	357	0,86	3882				B14/B5	B14/B5	
70		20	3	1,0	3,1	351	0,84	4273				B14/B5	B14/B5	
56		25	2,2	1,1	2,4	332	0,82	4603				B14/B5	B14/B5	
47		30	2,2	1,2	2,6	415	0,78	4891				B14/B5	B14/B5	
35		40	1,5	1,2	1,8	363	0,75	5383	24		B14/B5	B14/B5		
28		50	1,1	1,3	1,4	339	0,72	5799			B14/B5	B14/B5		
23		60	1,1	1,0	1,1	307	0,69	6163			B14/B5	B14/B5		
18		80	0,75	1,1	0,83	285	0,63	6783		19		B14/B5		
14		100	0,55	1,2	0,67	270	0,59	7306			B14/B5			