

MODELO	UMSG110	
Ø EJE DE SALIDA	42	mm
RELACIÓN APROXIMADA	30	
RELACIÓN EXACTA	30.00	
VELOCIDAD DE SALIDA	49	RPM
VELOCIDAD DE SALIDA EXACTA	49	RPM
POTENCIA DE ENTRADA	1.50	KW
ROTACIÓN DE ENTRADA	1400	RPM
PAM DE ENTRADA	90B14	
PAR DE SALIDA	242.48	N.m
PAR NOMINAL	727.45	N.m
POTENCIA NOMINAL	4.5	KW
FACTOR DE SERVICIO	3.00	
EFICIENCIA DINÁMICA	0.79	



Cantidad de Aceite (L)

B3/H1	B6/H4	B7/H3	B8/H2	V5/H5	V6/H6
3	2.5	2.5	2.2	3	2.2

Cargas Radiales y Axiales



n_2 [min ⁻¹]	FA [N]	FR [N]
200	600	2900
100	750	3600
50	920	4600
15	1400	7000

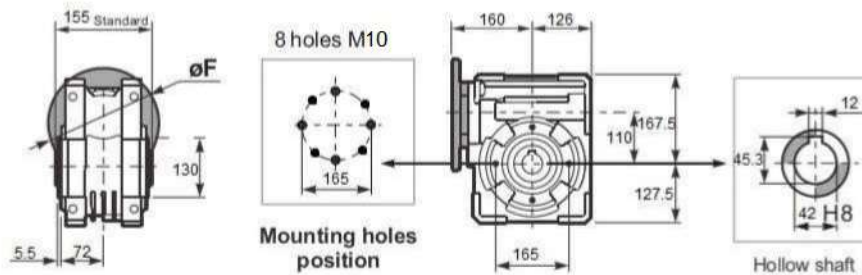

Square flange FA

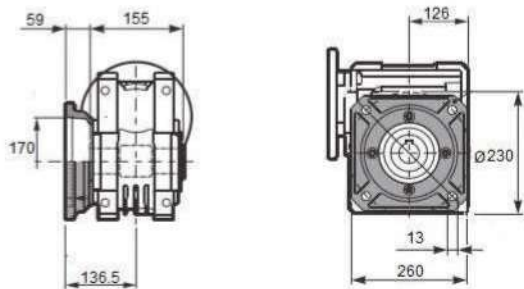

Single Shaft



b1	c1	d1	e1	m1	n1	t2	o1
12	80	42	84.5	155	249	45	M16

Feet

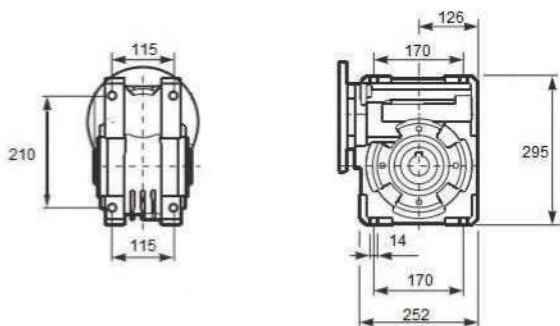

Reaction arm

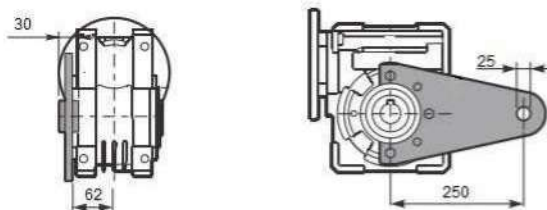

1400 rpm	N2	Relação	P1	F5	P1n	M2	Rend.	Fr max	Veio		Flanges de entrada			
	rpm	i	kW		kW	Nm	%	N	Entrada	Saída	80	90	100/112	132
UMSG110	187	7,5	7,5	1,6	12	546	0,9	3893	38				B14/B5	B14/B5
	140	10	7,5	1,3	9,8	588	0,89	4285					B14/B5	B14/B5
	93	15	7,5	1,0	7,5	660	0,86	4905					B14/B5	B14/B5
	70	20	5,5	1,0	5,6	649	0,85	5399					B14/B5	B14/B5
	56	25	5,5	1,0	5,7	665	0,84	5816	28	42			B14/B5	B14/B5
	47	30	4,0	1,1	4,5	727	0,79	6181					B14/B5	B14/B5
	35	40	3,0	1,1	3,3	693	0,78	6803					B14/B5	B14/B5
	28	50	2,2	1,2	2,6	656	0,75	7325					B14/B5	B14/B5
	23	60	1,5	1,4	2,1	620	0,72	7787	24				B14/B5	B14/B5
	18	80	1,5	0,9	1,4	512	0,67	8571					B5	B14/B5
	14	100	1,1	1,0	1,1	473	0,63	9232					B5	B14/B5