

Ficha Técnica
 Reductor de velocidad
 SIN-FIN CORONA CUADRADO

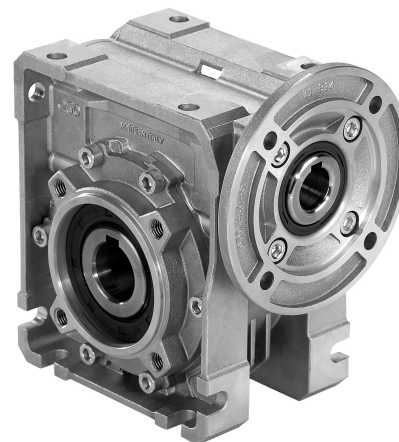

MODELO	M30	
Ø EJE DE SALIDA	14	mm
RELACIÓN APROXIMADA	60	
RELACIÓN EXACTA	61.00	
VELOCIDAD DE SALIDA	24	RPM
VELOCIDAD DE SALIDA EXACTA	24	RPM
POTENCIA DE ENTRADA	0.09	KW
ROTACIÓN DE ENTRADA	1400	RPM
PAM DE ENTRADA	56B5	
PAR DE SALIDA	18.72	N.m
PAR NOMINAL	20.00	N.m
POTENCIA NOMINAL	0.1	KW
FACTOR DE SERVICIO	1.11	
EFICIENCIA DINÁMICA	0.50	



Cantidad de Aceite (L)

B3/H1	B6/H4	B7/H3	B8/H2	V5/H5	V6/H6
0.03	0.03	0.03	0.03	0.03	0.03

Cargas Radiales y Axiales



n_2 [min-1]	FA [N]	FR [N]
200	120	600
100	160	800
50	200	1000
15	280	1400

Universal Motors S.A.
 Rua Comendador Brandão, 484
 4495-375 Póvoa de Varzim
geral@universalmotors.pt
 TEL.: 252 299 080

Universal Motors UK, Ltd
 Unit E2, Meltham Mills Road
 West Yorkshire HD9 4AR
enquiries@universalmotors-group.co.uk
 TEL.: +44(0) 1484660222

Universal Motors SL
 C/La Habana n.6 nave 4 PI Camporoso
 28806 Alcalá de Henares
info@universalmotors-group.es
 TEL.: 918 864 213

PM30**FB**... Basic wormbox
Riduttore base

Gearbox weight
peso riduttore **1.15 kg**

M. flanges	Kit code	øF	A
56B5	K030.4.041	120	61.5
63B5	K030.4.042	140	62.5
56B14	K030.4.046	80	61.5
63B14	K030.4.045	90	62.5



PM30**FC**... Square flange
Flangia quadrata



PM30**FB**... Feet
Piedini



PM30**BR**... Reaction arm
Braccio di reazione



RM30FB... Input shaft
Albero in entrata



PM30....**S**... Single Shaft
Albero lento semplice

PM30....**D**... Double Shaft
Albero lento bisp.



① kit cod. K030.5.028 type B

② kit cod. K030.5.029 type B

	ød	e	g	l	m	x	kit code
type B	9 h6	10.2	3	20	58	-	K030.5.006 PAM63
type S	-	-	-	-	-	-	-

	b1	c1	d1	e1	f1	l1	m1	n1	t2	o1
type B	5	25	14 ^{-0.005} _{-0.020}	35.5	55	126	59	94.5	16	M5x14
type S	-	-	-	-	-	-	-	-	-	-