

Ficha Técnica  
 Reductor de velocidad  
 SIN-FIN CORONA CUADRADO



MODELO	M45	
Ø EJE DE SALIDA	18	mm
RELACIÓN APROXIMADA	70	
RELACIÓN EXACTA	70.00	
VELOCIDAD DE SALIDA	21	RPM
VELOCIDAD DE SALIDA EXACTA	21	RPM
POTENCIA DE ENTRADA	0.12	KW
ROTACIÓN DE ENTRADA	1400	RPM
PAM DE ENTRADA	63B5	
PAR DE SALIDA	30.94	N.m
PAR NOMINAL	30.00	N.m
POTENCIA NOMINAL	0.12	KW
FACTOR DE SERVICIO	1.00	
EFICIENCIA DINÁMICA	0.54	



Cantidad de Aceite (L)

B3/H1	B6/H4	B7/H3	B8/H2	V5/H5	V6/H6
0.09	0.09	0.09	0.09	0.09	0.09

Cargas Radiales y Axiales



$n_2$ [min-1]	FA [N]	FR [N]
200	180	900
100	220	1100
50	260	1400
15	400	2000

Universal Motors S.A.  
 Rua Comendador Brandão, 484  
 4495-375 Póvoa de Varzim  
[geral@universalmotors.pt](mailto:geral@universalmotors.pt)  
 TEL.: 252 299 080

Universal Motors UK, Ltd  
 Unit E2, Meltham Mills Road  
 West Yorkshire HD9 4AR  
[enquiries@universalmotors-group.co.uk](mailto:enquiries@universalmotors-group.co.uk)  
 TEL.: +44(0) 1484660222

Universal Motors SL  
 C/La Habana n.6 nave 4 PI Camporoso  
 28806 Alcalá de Henares  
[info@universalmotors-group.es](mailto:info@universalmotors-group.es)  
 TEL.: 918 864 213

**PM45FB...** Basic wormbox  
Riduttore base

M. flanges	Kit code	øF	A
<b>63B5</b>	K050.4.041	138	80
<b>71B5</b>	K050.4.042	160	77.5
<b>56B14</b>	KC40.4.049	80	77.5
<b>63B14</b>	K050.4.047	90	80
<b>71B14</b>	K050.4.045	105	77.5

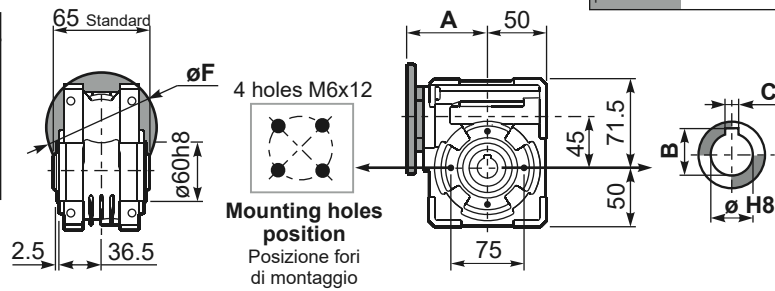

Gearbox weight  
peso riduttore **2.30 kg**

ø H8	B	C	*Spacer code
<b>18</b> Standard	20.8	6	KM45.3.018
<b>19</b> on request	21.8	6	KM45.3.019
<b>20</b> on request	22.8	6	KM45.3.020

\*On Request  
output shaft with spacers

**PM45FC...** Square flange  
Flangia quadrata

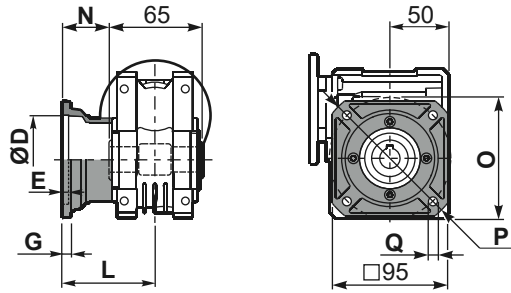

type B	øD	E	G	L	N	O	P	Q	kit code
<b>FC</b>	60 H8	4	7	67	34.5	75	110	9	KM45.9.010
<b>FL</b>	60 H8	4	7	97	64.5	75	110	9	KM45.9.011

**PM45F1...** Round flange  
Flangia rotonda

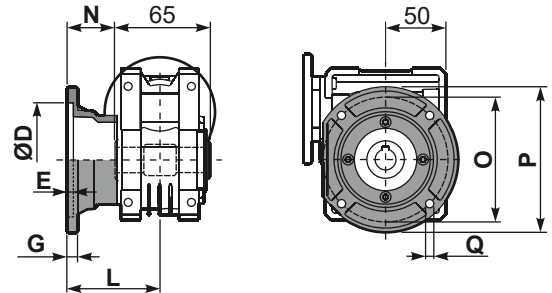

type S	øD	E	G	L	N	O	P	Q	kit code
<b>F1</b>	95H8	5	9	80	47.5	115	140	9.5	KM45.9.012
<b>F2</b>	-	-	-	-	-	-	-	-	-

**PM45FB...** Feet  
Piedini

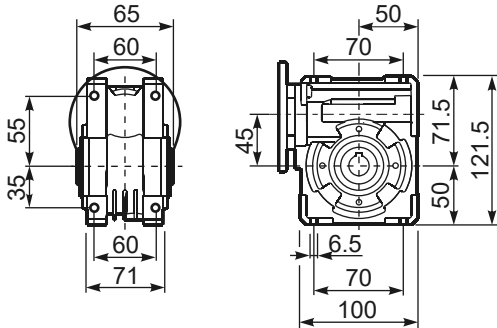

**PM45BR...** Reaction arm  
Braccio di reazione

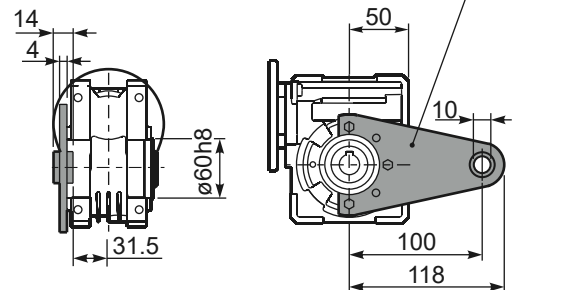

**RM45FB...** Input shaft  
Albero in entrata

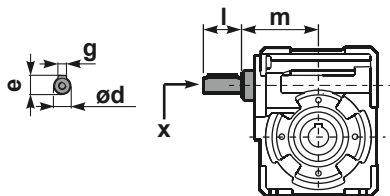

	ød	e	g	l	m	x	kit code
type B	11 h6	12.5	4	30	74	-	① K045.5.006 PAM71 ② - ③ -
type S	-	-	-	-	-	-	① - ② - ③ -

**PM45.....S...** Single Shaft  
Albero lento semplice

**PM45.....D...** Double Shaft  
Albero lento bisp.

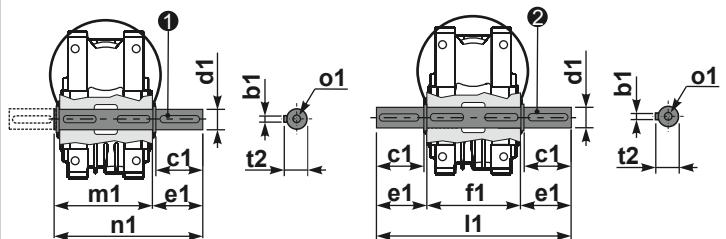

① kit cod. K045.5.028 type B  
kit cod. KS045.5.030 type S  
② kit cod. K045.5.029 type B

	b1	c1	d1	e1	f1	l1	m1	n1	t2	o1
type B	6	32	18 <sup>-0.005</sup> <sub>-0.020</sub>	43	65	151	70	113	20.5	M6x18
type S	6	40	19 <sup>-0.005</sup> <sub>-0.020</sub>	58.5	-	-	70	128.5	21.5	M8x20