

Ficha Técnica
 Reductor de velocidad
 SIN-FIN CORONA CUADRADO



MODELO	Q75	
Ø EJE DE SALIDA	30	mm
RELACIÓN APROXIMADA	7	
RELACIÓN EXACTA	7.00	
VELOCIDAD DE SALIDA	209	RPM
VELOCIDAD DE SALIDA EXACTA	209	RPM
POTENCIA DE ENTRADA	4.00	KW
ROTACIÓN DE ENTRADA	1400	RPM
PAM DE ENTRADA	112B5	
PAR DE SALIDA	171.89	N.m
PAR NOMINAL	190.00	N.m
POTENCIA NOMINAL	4.4	KW
FACTOR DE SERVICIO	1.10	
EFICIENCIA DINÁMICA	0.90	



Cantidad de Aceite (L)

B3/H1	B6/H4	B7/H3	B8/H2	V5/H5	V6/H6
0.4	0.4	0.4	0.4	0.4	0.4

Cargas Radiales y Axiales



n_2 [min-1]	FA [N]	FR [N]
200	460	2300
100	560	2800
50	720	3600
15	1000	5000

Universal Motors S.A.
 Rua Comendador Brandão, 484
 4495-375 Póvoa de Varzim
geral@universalmotors.pt
 TEL.: 252 299 080

Universal Motors UK, Ltd
 Unit E2, Meltham Mills Road
 West Yorkshire HD9 4AR
enquiries@universalmotors-group.co.uk
 TEL.: +44(0) 1484660222

Universal Motors SL
 C/La Habana n.6 nave 4 PI Camporoso
 28806 Alcalá de Henares
info@universalmotors-group.es
 TEL.: 918 864 213

PQ75FB... Basic wormbox
Riduttore base

Gearbox weight
peso riduttore **8.70 kg**

M. flanges	Kit code	øF	A
71B5	K023.4.041	160	114
80/90B5	K023.4.042	200	116
100/112B5	K023.4.043	250	125
80B14	K085.4.046	120	116
90B14	K085.4.045	140	116
100/112B14	K085.4.047	160	125

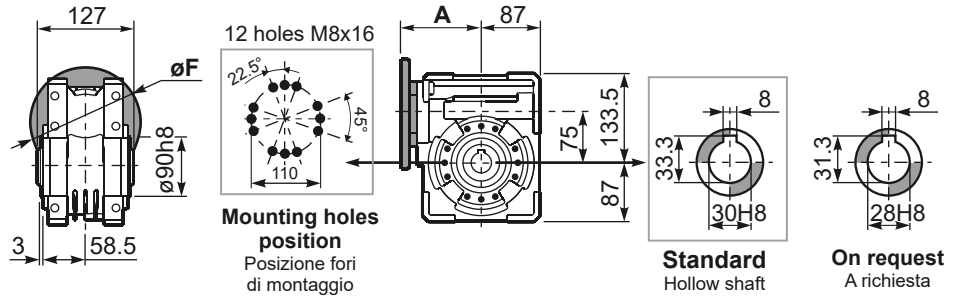

PQ75FC... Square flange
Flangia quadrata

PQ75FL... Square flange
Flangia quadrata

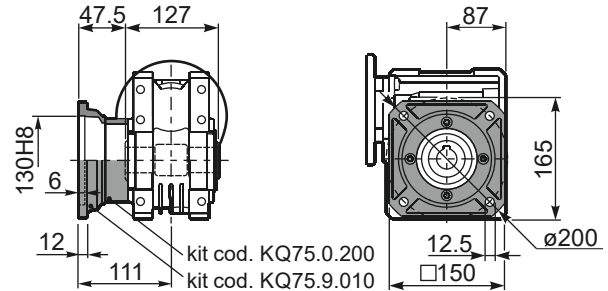
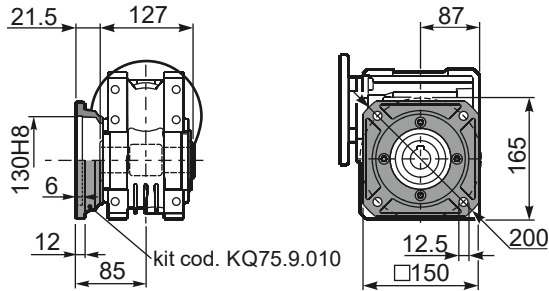

PQ75FB... Feet
Piedini

PQ75BR... Reaction arm
Braccio di reazione

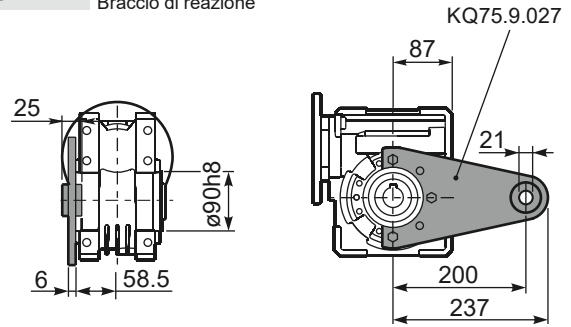
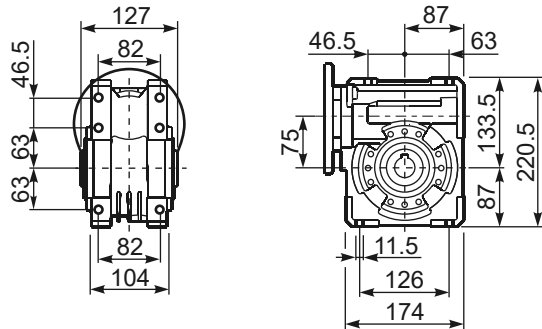

RQ75FB... Input shaft
Albero in entrata

PQ75....S... Single Shaft
Albero lento semplice

PQ75....D... Double Shaft
Albero lento bisp.

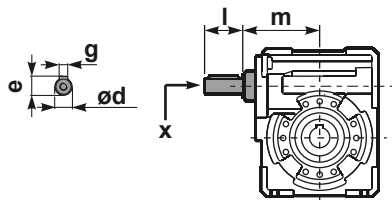

① kit cod. KQ75.5.028 Standard
kit cod. KQ75.5.026 On request

② kit cod. KQ75.5.029 Standard

	ød	e	g	l	m	x	kit code
type B	25 h6	27.8	8	50	109.5	M8x20	KQ75.5.006 PAM80 K085.5.007 PAM90 K085.5.008 PAM100

	b1	c1	d1	e1	f1	l1	m1	n1	t2	o1
Standard	8	60	30 ^{-0.005} _{-0.020}	65	127	255	134	199	33	M8x20
On request	8	60	28 ^{-0.005} _{-0.020}	65	-	-	134	199	31	M8x20