

Ficha Técnica
 Reductor de velocidad
 SIN-FIN CORONA CUADRADO



MODELO	M13	
Ø EJE DE SALIDA	45	mm
RELACIÓN APROXIMADA	10	
RELACIÓN EXACTA	10.00	
VELOCIDAD DE SALIDA	146	RPM
VELOCIDAD DE SALIDA EXACTA	146	RPM
POTENCIA DE ENTRADA	5.50	KW
ROTACIÓN DE ENTRADA	1400	RPM
PAM DE ENTRADA	132B5	
PAR DE SALIDA	333.88	N.m
PAR NOMINAL	820.00	N.m
POTENCIA NOMINAL	13.5	KW
FACTOR DE SERVICIO	2.45	
EFICIENCIA DINÁMICA	0.89	



Cantidad de Aceite (L)

B3/H1	B6/H4	B7/H3	B8/H2	V5/H5	V6/H6
4.5	3.5	3.5	3.3	4.5	3.3

Cargas Radiales y Axiales



n_2 [min ⁻¹]	FA [N]	FR [N]
200	960	4800
100	1240	6200
50	1560	7800
15	2400	12000

Universal Motors S.A.
 Rua Comendador Brandão, 484
 4495-375 Póvoa de Varzim
geral@universalmotors.pt
 TEL.: 252 299 080

Universal Motors UK, Ltd
 Unit E2, Meltham Mills Road
 West Yorkshire HD9 4AR
enquiries@universalmotors-group.co.uk
 TEL.: +44(0) 1484660222

Universal Motors SL
 C/La Habana n.6 nave 4 PI Camporoso
 28806 Alcala de Henares
info@universalmotors-group.es
 TEL.: 918 864 213

PM13**FB**... Basic wormbox
Riduttore base

Gearbox weight
peso riduttore **48.0 kg**

M. flanges	Kit code	øF	A
90B5	KM13.4.041	200	180
100/112B5	KM13.4.042	250	180
132B5	KM13.4.043	300	180



PM13**FC**... Square flange
Flangia quadrata

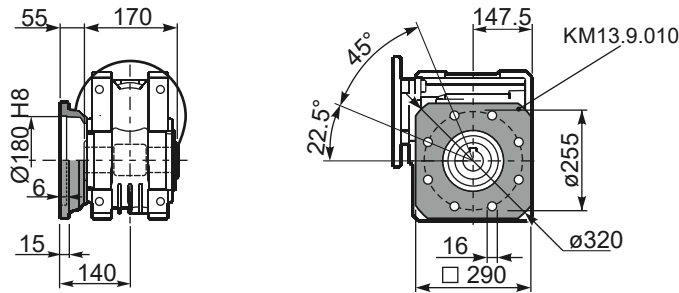

PM13**FB**... Feet
Piedini

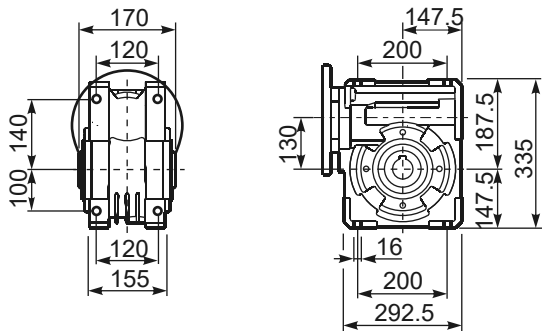

PM13**BR**... Reaction arm
Braccio di reazione



PM13....**S**... Single Shaft
Albero lento semplice

PM13....**D**... Double Shaft
Albero lento bisp.



① kit cod. KM13.5.028 type B

② kit cod. KM13.5.029 type B

	b1	c1	d1	e1	f1	l1	m1	n1	t2	o1
type	14	80	45 ^{-0.005} _{-0.020}	85	170	340	180	265	48.5	M16
type	-	-	-	-	-	-	-	-	-	-