

Ficha Técnica
 Reductor de velocidad
 SIN-FIN CORONA CUADRADO



MODELO	M15	
Ø EJE DE SALIDA	50	mm
RELACIÓN APROXIMADA	10	
RELACIÓN EXACTA	10.00	
VELOCIDAD DE SALIDA	146	RPM
VELOCIDAD DE SALIDA EXACTA	146	RPM
POTENCIA DE ENTRADA	9.20	KW
ROTACIÓN DE ENTRADA	1400	RPM
PAM DE ENTRADA	132B5	
PAR DE SALIDA	564.77	N.m
PAR NOMINAL	1240.00	N.m
POTENCIA NOMINAL	20.2	KW
FACTOR DE SERVICIO	2.20	
EFICIENCIA DINÁMICA	0.90	



Cantidad de Aceite (L)

B3/H1	B6/H4	B7/H3	B8/H2	V5/H5	V6/H6
7	5.4	5.4	5.1	7	5.1

Cargas Radiales y Axiales



n_2 [min ⁻¹]	FA [N]	FR [N]
200	1300	6500
100	1640	8200
50	2120	10600
15	3300	16500

Universal Motors S.A.
 Rua Comendador Brandão, 484
 4495-375 Póvoa de Varzim
geral@universalmotors.pt
 TEL.: 252 299 080

Universal Motors UK, Ltd
 Unit E2, Meltham Mills Road
 West Yorkshire HD9 4AR
enquiries@universalmotors-group.co.uk
 TEL.: +44(0) 1484660222

Universal Motors SL
 C/La Habana n.6 nave 4 PI Camporoso
 28806 Alcalá de Henares
info@universalmotors-group.es
 TEL.: 918 864 213

PM15**FB**... Basic wormbox
Riduttore base

Gearbox weight
peso riduttore **84.0 kg**

M. flanges	Kit code	øF	A
100/112B5	KM15.4.042	250	210
132B5	KM15.4.043	300	210
160B5	KM15.4.044	350	210



PM15**FC**... Square flange
Flangia quadrata



PM15**FB**... Feet
Piedini

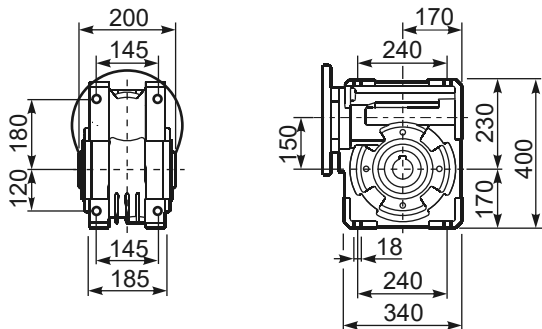

PM15**BR**... Reaction arm
Braccio di reazione



PM15....**S**... Single Shaft
Albero lento semplice

PM15....**D**... Double Shaft
Albero lento bisp.



① kit cod. KM15.5.028 type B

② kit cod. KM15.5.029 type B

	b1	c1	d1	e1	f1	l1	m1	n1	t2	o1
type	14	82	50 ^{-0.005} _{-0.020}	87	200	374	210	297	53.5	M16
type	-	-	-	-	-	-	-	-	-	-