

MODELO	X225	
Ø VEIO SAÍDA	20	mm
RÁCIO APROXIMADO	11	
RÁCIO EXATO	10.98	
VELOCIDADE SAÍDA	133	RPM
VELOCIDADE SAÍDA EXATA	133	RPM
POTÊNCIA ENTRADA	0.18	KW
ROTAÇÃO ENTRADA	1400	RPM
PAM ENTRADA	63B14	
TORQUE SAÍDA	12.94	N.m
TORQUE NOMINAL	45.00	N.m
POTÊNCIA NOMINAL	0.63	KW
FATOR SERVIÇO	3.50	
EFICIÊNCIA DINÂMICA	0.96	

QUANTIDADE DE ÓLEO (L)

B3/H1	B6/H4	B7/H3	B8/H2	V5/H5	V6/H6
0.25	0.25	0.25	0.25	0.43	0.31

CARGAS RADIAIS E AXIAIS



n_2 [min-1]	F_A [N]	F_R [N]
400	360	1800
150	420	2100
75	440	2200
25	440	2200

PX22SC... Basic Gearbox
Riduttore base

Gearbox weight
peso riduttore **3.70 kg**

M. flanges	Kit code	øF	A
63B5	K050.4.041	138	154.5
71B5	K050.4.042	160	152
56B14	KC40.4.049	80	152
63B14	K050.4.047	90	154.5
71B14	K050.4.045	105	152

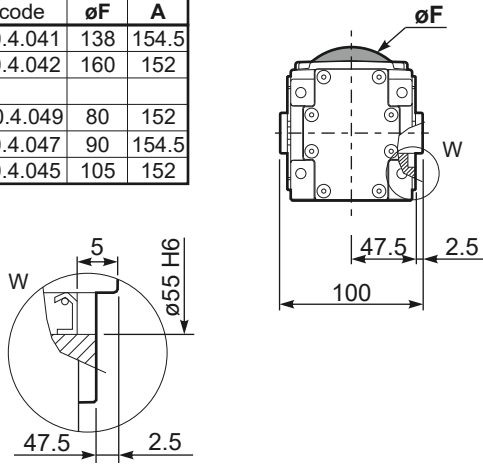

PX22S...**FB**.. Feet
Piedini



PX22S...**-F1**.. Output flange
Flangia uscita



PX22S**A**.. Single output shaft
Albero semplice in uscita



PX22S...**BR**.. Reaction Arm
Braccio di reazione

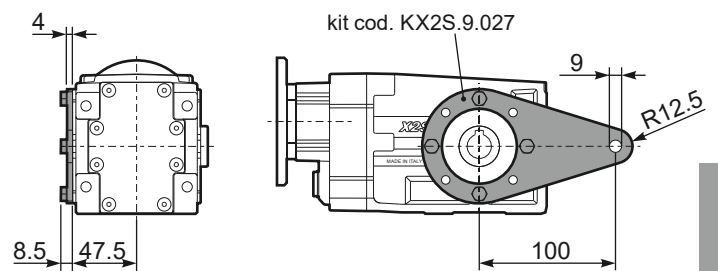

RX22S.. Input shaft
Albero in entrata

