

MODELO	X43A	
Ø VEIO SAÍDA	25	mm
RÁCIO APROXIMADO	72	
RÁCIO EXATO	71.78	
VELOCIDADE SAÍDA	20	RPM
VELOCIDADE SAÍDA EXATA	20	RPM
POTÊNCIA ENTRADA	0.12	KW
ROTAÇÃO ENTRADA	1400	RPM
PAM ENTRADA	63B14	
TORQUE SAÍDA	55.23	N.m
TORQUE NOMINAL	150.00	N.m
POTÊNCIA NOMINAL	0.33	KW
FATOR SERVIÇO	2.75	
EFICIÊNCIA DINÂMICA	0.94	

QUANTIDADE DE ÓLEO (L)

B3/H1	B6/H4	B7/H3	B8/H2	V5/H5	V6/H6
0.8	0.8	0.6	0.8	1.2	0.7

CARGAS RADIAIS E AXIAIS



n_2 [min-1]	F_A [N]	F_R [N]
250	500	2500
100	700	3500
50	960	4800
15	960	4800

PX43AC... Basic Gearbox
Riduttore base

Gearbox weight
peso riduttore **7.93 kg**

M. flanges	Kit code	øF	A
63B5	K050.4.041	138	205
71B5	K050.4.042	160	202.5
56B14	KC40.4.049	80	202.5
63B14	K050.4.047	90	205
71B14	K050.4.045	105	202.5



PX43A...FB.. Feet
Piedini



PX43A...-F2.. Output flange
Flangia uscita

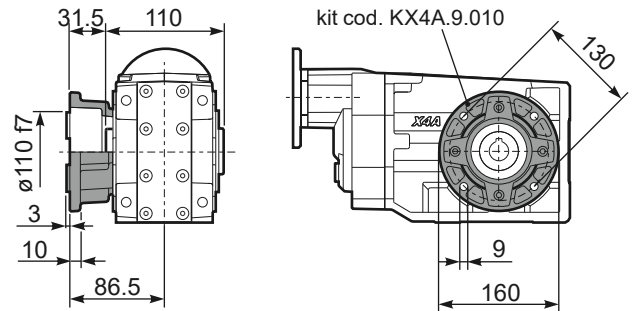

PX43A...-F3.. Output flange
Flangia uscita



PX43A...BR.. Reaction Arm
Braccio di reazione



RX43A... Input shaft
Albero in entrata



PX43AA.. Single output shaft
Albero semplice in uscita

