

MODELO	X52A	
Ø VEIO SAÍDA	30	mm
RÁCIO APROXIMADO	15	
RÁCIO EXATO	15.36	
VELOCIDADE SAÍDA	97	RPM
VELOCIDADE SAÍDA EXATA	95	RPM
POTÊNCIA ENTRADA	3.00	KW
ROTAÇÃO ENTRADA	1400	RPM
PAM ENTRADA	100B14	
TORQUE SAÍDA	301.74	N.m
TORQUE NOMINAL	250.00	N.m
POTÊNCIA NOMINAL	2.5	KW
FATOR SERVIÇO	0.83	
EFICIÊNCIA DINÂMICA	0.96	

QUANTIDADE DE ÓLEO (L)

B3/H1	B6/H4	B7/H3	B8/H2	V5/H5	V6/H6
0.9	1.5	0.75	1.4	1.95	1.15

CARGAS RADIAIS E AXIAIS



n_2 [min-1]	F_A [N]	F_R [N]
250	600	3000
100	800	4000
50	960	4800
15	1660	8300

PX52AC... Basic Gearbox
Riduttore base

Gearbox weight **12.80 kg**
peso riduttore

M. flanges	Kit code	øF	A
71B5	K023.4.041	160	234
80/90B5	K023.4.042	200	236
100/112B5	K023.4.043	250	245
80B14	K085.4.046	120	236
90B14	K085.4.045	140	236
100/112B14	K085.4.047	160	245



PX52A...FB.. Feet
Piedini

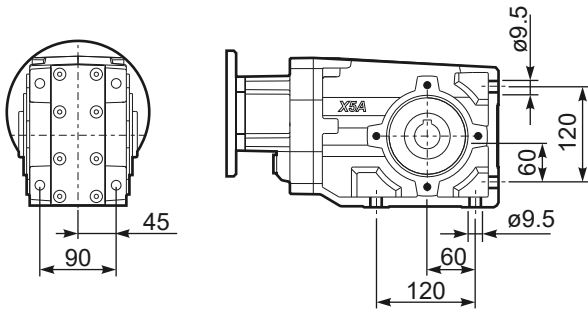

PX52A...-F2.. Output flange
Flangia uscita



PX52A...-F3.. Output flange
Flangia uscita



PX52A...-F4.. Output flange
Flangia uscita



RX52A... Input shaft
Albero in entrata



PX52A...BR.. Reaction Arm
Braccio di reazione



PX52AA.. Single output shaft
Albero semplice in uscita

