

MODELO	X63A	
Ø VEIO SAÍDA	35	mm
RÁCIO APROXIMADO	126	
RÁCIO EXATO	125.82	
VELOCIDADE SAÍDA	12	RPM
VELOCIDADE SAÍDA EXATA	12	RPM
POTÊNCIA ENTRADA	0.55	KW
ROTAÇÃO ENTRADA	1400	RPM
PAM ENTRADA	80B14	
TORQUE SAÍDA	443.69	N.m
TORQUE NOMINAL	410.00	N.m
POTÊNCIA NOMINAL	0.51	KW
FATOR SERVIÇO	0.93	
EFICIÊNCIA DINÂMICA	0.94	

QUANTIDADE DE ÓLEO (L)

B3/H1	B6/H4	B7/H3	B8/H2	V5/H5	V6/H6
1.8	1.8	1.05	1.7	2.6	1.65

CARGAS RADIAIS E AXIAIS



n_2 [min-1]	F_A [N]	F_R [N]
250	600	3000
100	780	3900
50	1140	5700
15	1660	8300

PX63AC... Basic Gearbox
Riduttore base

Gearbox weight **15.98 kg**
peso riduttore

M. flanges	Kit code	øF	A
63B5	K063.4.041	140	265
71B5	K063.4.042	160	263
80/90B5	K063.4.043	200	265
71B14	K063.4.047	105	263
80B14	K063.4.046	120	265
90B14	K063.4.041	140	265

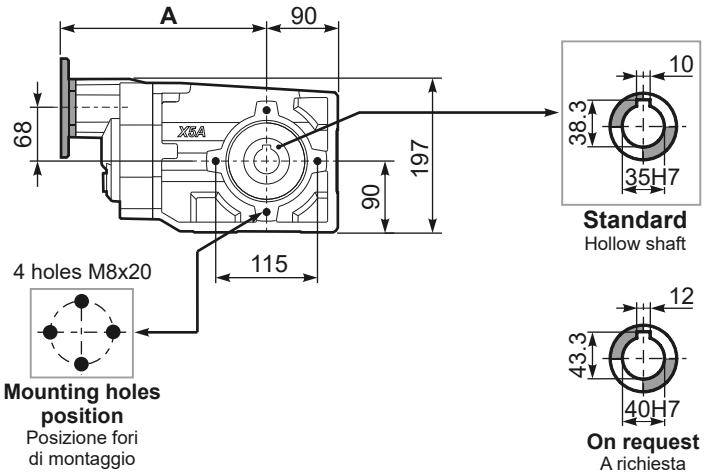
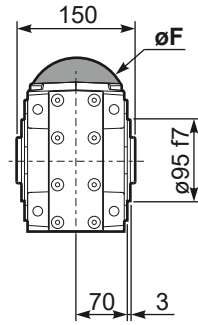

PX63A...FB.. Feet
Piedini



PX63A...-F2.. Output flange
Flangia uscita

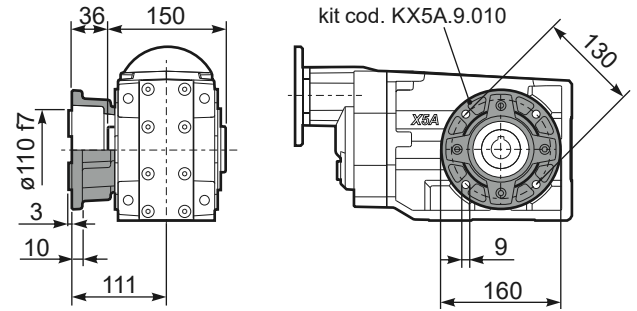

PX63A...-F3.. Output flange
Flangia uscita

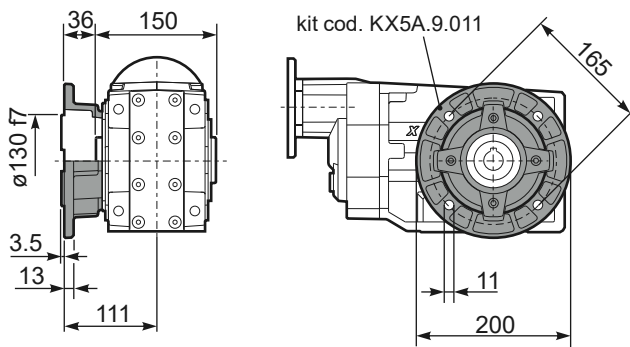

PX63A...-F4.. Output flange
Flangia uscita



RX63A... Input shaft
Albero in entrata

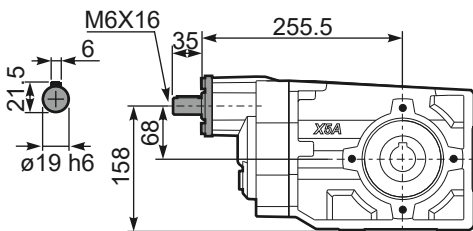

PX63A...BR.. Reaction Arm
Braccio di reazione



PX63AA.. Single output shaft
Albero semplice in uscita

