

MODELO	X63A	
Ø VEIO SAÍDA	35	mm
RÁCIO APROXIMADO	77	
RÁCIO EXATO	77.23	
VELOCIDADE SAÍDA	19	RPM
VELOCIDADE SAÍDA EXATA	19	RPM
POTÊNCIA ENTRADA	0.37	KW
ROTAÇÃO ENTRADA	1400	RPM
PAM ENTRADA	71B5	
TORQUE SAÍDA	183.21	N.m
TORQUE NOMINAL	410.00	N.m
POTÊNCIA NOMINAL	0.83	KW
FATOR SERVIÇO	2.24	
EFICIÊNCIA DINÂMICA	0.94	

QUANTIDADE DE ÓLEO (L)

B3/H1	B6/H4	B7/H3	B8/H2	V5/H5	V6/H6
1.8	1.8	1.05	1.7	2.6	1.65

CARGAS RADIAIS E AXIAIS



$n_2$ [min-1]	$F_A$ [N]	$F_R$ [N]
250	600	3000
100	780	3900
50	1140	5700
15	1660	8300

**PX63AC...** Basic Gearbox  
Riduttore base

Gearbox weight **15.98 kg**  
peso riduttore

M. flanges	Kit code	øF	A
<b>63B5</b>	K063.4.041	140	265
<b>71B5</b>	K063.4.042	160	263
<b>80/90B5</b>	K063.4.043	200	265
<b>71B14</b>	K063.4.047	105	263
<b>80B14</b>	K063.4.046	120	265
<b>90B14</b>	K063.4.041	140	265



**PX63A...FB..** Feet  
Piedini

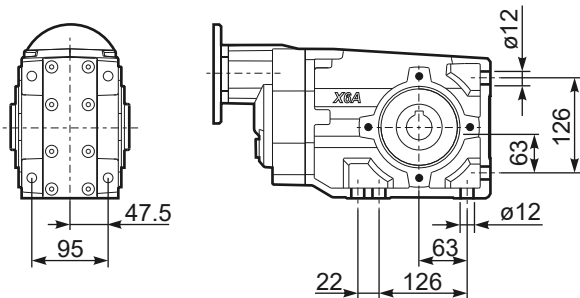

**PX63A...-F2..** Output flange  
Flangia uscita



**PX63A...-F3..** Output flange  
Flangia uscita



**PX63A...-F4..** Output flange  
Flangia uscita



**RX63A...** Input shaft  
Albero in entrata



**PX63A...BR..** Reaction Arm  
Braccio di reazione

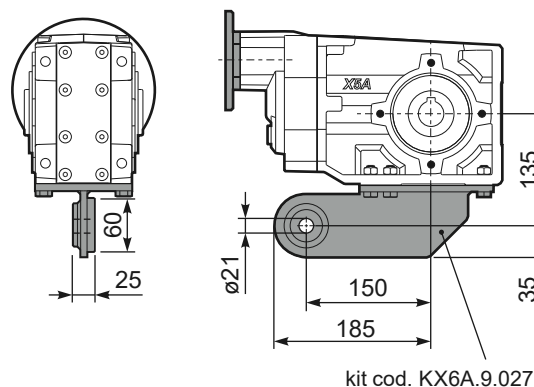

**PX63AA..** Single output shaft  
Albero semplice in uscita

