

MODELO	FA43	
Ø VEIO SAÍDA	30	mm
RÁCIO APROXIMADO	100	
RÁCIO EXATO	101.40	
VELOCIDADE SAÍDA	15	RPM
VELOCIDADE SAÍDA EXATA	14	RPM
POTÊNCIA ENTRADA	0.25	KW
ROTAÇÃO ENTRADA	1400	RPM
PAM ENTRADA	71B5	
TORQUE SAÍDA	162.54	N.m
TORQUE NOMINAL	320.00	N.m
POTÊNCIA NOMINAL	0.49	KW
FATOR SERVIÇO	1.96	
EFICIÊNCIA DINÂMICA	0.94	



QUANTIDADE DE ÓLEO (L)

B3/H1	B6/H4	B7/H3	B8/H2	V5/H5	V6/H6
1.101	0.7	0.7	0.7	1.35	0.9

CARGAS RADIAIS E AXIAIS



$n_2$ [min-1]	FA [N]	FR [N]
300	300	1500
200	350	1750
120	410	2050
15	800	4000

## PFA43C...

Basic gearbox  
Riduttore base

Gearbox weight  
peso riduttore **8.9 kg**

M. flanges	Kit code	øF	A
63B5	K050.4.041	138	175
71B5	K050.4.042	160	172.5
56B14	KC40.4.049	80	172.5
63B14	K050.4.047	90	175
71B14	K050.4.045	105	172.5

● Available torque arms,  
see our web site  
Bracci di reazione disponibili,  
consulta il nostro sito web



**Standard**  
Hollow shaft

**On request**  
A richiesta

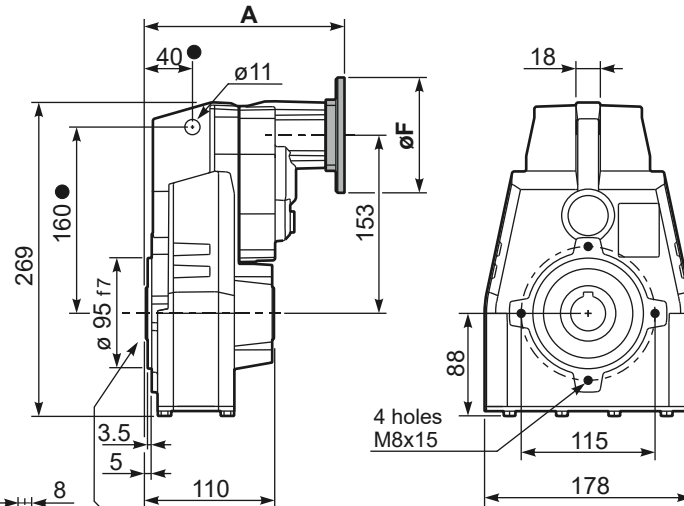

## PFA43...-F...

Output flange  
Flangia uscita

Motor Flange	k1
63B5	211
71B5	208.5
56B14	208.5
63B14	211
71B14	208.5

Available output flanges  
Flange di uscita

a1 ø	b1	c1	e1	f1	s1	Kit code
160	110	10	130	3	9	KX5A.9.010
200	130	13	165	3.5	11	KX5A.9.011
250	180	14	215	4	14	KX5A.9.012

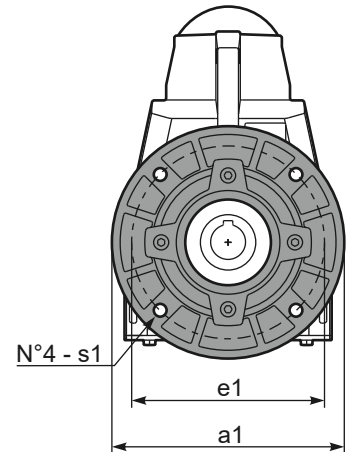

## RFA43C...

Input Shaft  
Albero in entrata

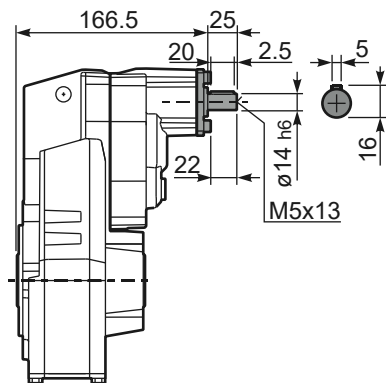

## PFA43 A...

Single output shaft  
Albero uscita semplice

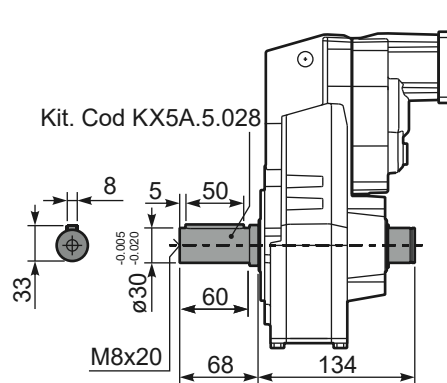

## PFA43D...

Shrink disk  
Calettatore

